

KEYS



10**Keys**

Key Machines	10.0005 - 10.0040	Saturn	10.0420 - 10.0425
Acura	10.0045	Subaru	10.0430
AMC	10.0050	Suzuki	10.0435 - 10.0440
Audi	10.0050	Toyota	10.0445 - 10.0455
BMW	10.0055	Volkswagen	10.0460
Buick	10.0060 - 10.0075	Volvo	10.0465
Cadillac	10.0080 - 10.0090	Motorcycles - Harley Davidson	10.0470
Chevrolet	10.0095 - 10.0130	Motorcycles - Honda	10.0475 - 10.0480
Chrysler	10.0135 - 10.0150	Motorcycles - Kawasaki	10.0485
Daewoo	10.0155	Motorcycles - Suzuki	10.0490
Dodge	10.0160 - 10.0175	Motorcycles - Yamaha	10.0495 - 10.0505
Eagle	10.0180 - 10.0185	Large Trucks - Daihatsu	10.0510
Ford	10.0190 - 10.0205	Large Trucks - Freightliner	10.0515
GM Truck	10.0210 - 10.0220	Large Trucks - HINO	10.0520 - 10.0525
Honda	10.0225 - 10.0235	Large Trucks - Navistar	10.0525
Hummer	10.0240	Large Trucks - Peterbuilt	10.0530
Hyundai	10.0245 - 10.0250	Large Trucks - White, GMC, Volvo	10.0530
Isuzu	10.0255 - 10.0260		
Jeep	10.0265 - 10.0275		
Kia	10.0280 - 10.0290		
Land Rover	10.0295		
Lexus	10.0300		
Lincoln	10.0305		
Mazda	10.0310 - 10.0315		
Mercedes-Benz	10.0320		
Mercury	10.0325 - 10.0330		
Mitsubishi	10.0335 - 10.0340		
Nissan	10.0345 - 10.0350		
Oldsmobile	10.0355 - 10.0375		
Plymouth	10.0380 - 10.0390		
Pontiac	10.0395 - 10.0410		
Saab	10.0415		

"AUTOCODE" KEY MACHINE

Computerized Key Machine

- Comes with a full code database included. Simply hit the Code key, enter key code, select vehicle model, choose & install key blank in vise, press "cut the key" & in about 15 seconds your key will be cut.
 - Note:** Not equipped to cut steel keys. Additional cutting wheel required. See cutting wheels below.
- Features a history function that will store key cutting depths & customer information. This is excellent for the customer who loses their keys or for a large business that frequently needs the same key cut. Re-entering code number or original work order, again, is not required to make another key.
- In the Configure mode this machine also features:
 - Complete control of who can access each menu
 - Creates log of users
 - Ability to change passwords to block or allow access to users
 - Backup/restore History functions.
 - Look-up and cut a key by manufacturer by simply entering the first few letters of the manufacturer and highlighting it in the table. Hit the enter key and all the spacing and key information is displayed as well as room to enter in the cuts of the key. Press the enter key and in about 15 seconds your key is ready to go.
- Using either the keyboard or mouse, you can choose Manufacturer, Codes, History or Machine. There are no special codes or reference materials needed with the program to access different manufacturers or code series. The software even features hints to let you know what any particular button is for.
- The WURTH AutoCode is backed by a one year, parts, labor & freight warranty. The control box inside the Autocode key machine is backed by a lifetime warranty.
- Laptop has a 30 day manufacturers warranty
- Autocode Key Machine w/CD ROM Version Software (Laptop not included) Art. # 170224000 (DS)
- Refurbished Laptops Installed w/Windows 95 for Autocode Key Machine Art. # 170224100 (DS)
- Autocode updates are available for purchase.

Laptop is a refurbished unit and has a 6 month warranty against manufacturer defects only.

Autocode Machine has a 1 year warranty against factory defects. This warranty does not cover the key vice or the cutting wheel.



Description	Art #
Autocode Machine	170224000 (DS)
Laptop Computer	170224100 (DS)

(DS) designates item is **D**rop **S**hipped

Minimum system requirements

The WURTH Autocode is designed to work with any 386 or higher PC compatible computer with a CD ROM 2x or higher. The software will require about 20 megabytes of disc space, and the computer must be running Windows 95.

It is recommended that the laptop be kept away from key chips.

Good



Better



Best



Update for Auto Code CD



Shoulder Stop

Description	Art #
Good: Standard Cutting Wheel	170223615
Better: Coated Cutting Wheel	170223620 (DS)
Best: Carbide Cutting Wheel for Steel Keys	170223625 (DS)
Shoulder Stop	170223616
Update for Autocode CD	170223600 (DS)

(DS) designates item is **D**rop **S**hipped

WURTH KEY DUPLICATOR

The **WURTH Key Duplicator** is a manual duplicator designed for automotive dealerships.

- Cuts transponder, Vats, and regular keys with speed and accuracy
- Accepts keys up to 4" in length
- 1 7/8" of key cutting travel
- Wire deburring brush included
- Reversible vises hold keys without tipping
- Flip-down key stop for aligning shouldered keys
- Sealed ball bearings in spindle assembly ensure long life
- Rod wipers keep chips off of yoke rod
- Adjustable guide makes calibration easy if needed
- Small and compact
- Aluminum and steel construction for durability and long life

The Key Duplicator comes with a 1 year warranty against factory defects only. This warranty does not cover the vices or the cutting wheel.

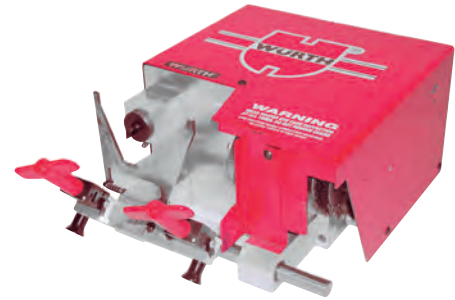

Description	Art #
WURTH Key Duplicator	170226000 (DS)
Replacement Cutting Wheel	170223610
Replacement Deburring Brush	170223611

(DS) designates item is **D**rop **S**hipped

SPACE KEYS FOR DUCODE KEY MACHINE (NEXT PAGE)

Key #	Art #
10	1702233001
11	1702233002
11A	1702233003
11B	1702233004
11M	1702233057
12	1702233005
13	1702233006
13A	1702233007
13C	1702233008
14	1702233009
14A	1702233010
14D	1702233011
14E	1702233012
14K	1702233062
15	1702233013
16	1702233014
18	1702233015
19	1702233016
21	1702233017
27	1702233018
28	1702233019
30	1702233020
40	1702233021
56A	1702233022
59	1702233023
64	1702233024
66	1702233025
66A	1702233026
71	1702233027
72	1702233028
90	1702233029
99	1702233030
108	1702233031

Key #	Art #
108B	1702233032
125	1702233033
125A	1702233034
131A	1702233035
134	1702233036
154	1702233037
155	1702233038
179	1702233039
198	1702233040
205	1702233041
207	1702233042
216	1702233043
227	1702233044
230	1702233045
239	1702233046
242	1702233047
243	1702233048
245	1702233049
247	1702233050
250	1702233051
251	1702233052
255	1702233061
260	1702233053
261	1702233054
262	1702233075
270	1702233055
270T	1702233058
273	1702233059
280	1702233056
300T	1702233060

Each of these keys are **DROP SHIPPED**



Key #	Make	Art #
1619	Yamaha	1702233063
1606	Suzuki, Honda	1702233064
1603	Honda	1702233065
1602	Kawasaki	1702233066
1632	Kawasaki	1702233067
1637	Kawasaki	1702233068
1628	Kawasaki	1702233069
1638	Kawasaki	1702233070
1621	Yamaha, Kawasaki	1702233071
1615	Yamaha	1702233072
1601	Yamaha, Suzuki	1702233073
1236	Honda	1702233074

WURTH DUCODE KEY MACHINE

Duplicates and Cuts by Code

- Keys can be code cut in less than 30 seconds
- Duplicate keys in less than 15 seconds
- Precision engineered
- Constructed of steel & aluminum
- Holds tolerances of .0005
- Sealed ball bearings are used throughout the machine
- Easily updated when new code series are introduced.
- Key kits available for most applications

Note: Not equipped to cut steel keys. Additional cutting wheel required.

The DuCode Key Machine comes with a 1 year warranty against factory defects. This warranty does not cover the vices or the cutting wheel.

Key Kits for DuCode Key Machine

Application	Art #
Chrysler products	170223280
Ford	170223282
GM / Geo	170223284
Honda / Acura	170223285
Hyundai	170223286
Isuzu	170223287
Kia	170223288

Application	Art #
Mazda	170223289
Mitsubishi	170223291
Nissan / Infiniti	170223292
Saturn	170223294
Subaru	170223295
Toyota	170223297

These items Drop Shipped



Description	Art #
WURTH DuCode Key Machine	070223000

This item is Drop Shipped

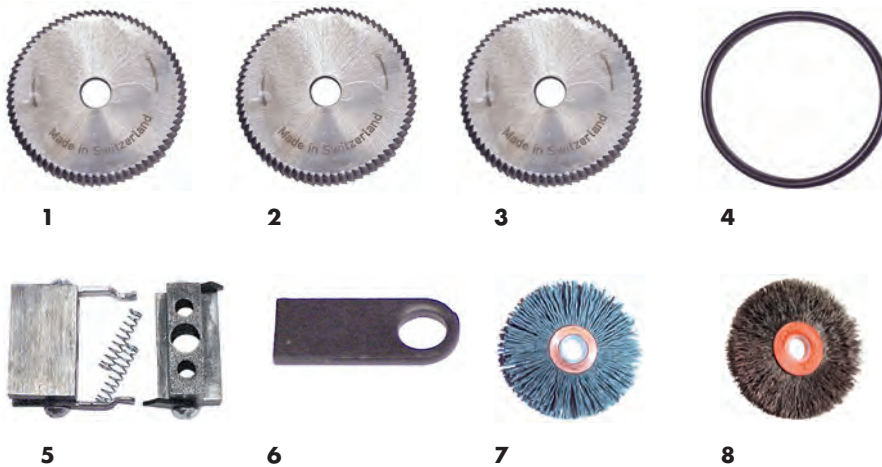

#	Description	Art #
1	Good: Standard Cutting Wheel	170229040
2	Better: Coated Cutting Wheel	170223620
3	Best: Carbide Cutting Wheel for Steel Keys	170223625
4	DuCode Drive Belt	170223613
5	DuCode Key Jaws	170223612
6	DuCode Tip Stop	170223614
7	DuCode Nylon Key Brush	170223611
8	DuCode Wire Key Brush	170223617

These items Drop Ship

Depth Cams



Application	Art #
Cam #1	0702231001
Cam #2	0702231002
Cam #3	0702231003
Cam #6	0702231006
Cam #11	0702231011
Cam #100	0702231100
Cam #200	0702231200

These items Drop Ship

ULTRACODE™ KEY MACHINE

- The Ultracode™ is an Electronic Key Cutting Machine for code cutting cylindrical, automotive and flat keys. This revolutionary machine is able to operate stand-alone or connected to a personal computer in conjunction with Ilco's Kreate-A-Key™ code software. No other Electronic Key Machine better meets the demands of today's professional key cutting centers.
- Duplication Function - A patented Laser Optical Reader allows Ultracode operators to quickly and easily duplicate single and double-sided keys.
- Extensive Code Database - The Ultracode is pre-loaded with over 1,300 digital depth and spacing cards for the precise cutting of cylindrical and automotive keys. Up to 200 user defined (Design-A-Key) cards can be created without the need for a personal computer, further enhancing the machine's extensive service and wide application range.
- Variety of Cut Types - A wide range of lock systems can be cut on the Ultracode including single-sided, double-sided, Medeco®, and Tibbe® keys. The on-board database software allows the operator to select the cut type (laser, regular, flat or plunge) best suited for the selected application.
- Duplication - Depth and spacing information read by the machine while decoding, is automatically converted to original lock specification when duplicating.
- Automatic Calibration - Quick and easy procedure that eliminates potential errors related to manual calibration.



Description	Art #
Ultracode™ Key Machine	170238000

The Ultracode comes with a 3 year warranty against factory defects only. This warranty does not cover the vices or cutting wheels.

TRI-CODE H.S. KEY MACHINE

- The Tri-Code H.S. is an electronic key machine specifically designed to be used by the automotive dealers and locksmiths to cut "laser style" high security keys by code number or duplication. Fast, easy to operate, the Tri-Code H.S. delivers consistent, dependable results!
- Simple to operate, this machine eliminates the guesswork and effort associated with cutting "laser type" automotive keys. In addition to providing "factory perfect" results when originating a key, the Tri-Code H.S. also excels when simply duplicating a key.
- Automatically Compensates for worn cuts when duplicating a key. If key wear is detected on the pattern (original) key, the machine automatically corrects it, producing a duplicate that is cut to original factory specifications with tolerances of +/- .001"
- Fast, Easy-To-Operate
- Electronically controlled operations
- Internal Database contains key codes and cut specifications for popular automotive "Laser Key Applications"
- Fully equipped, ready to cut keys
- 3 Year Factory Warranty from date of purchase



Description	Art #
Tri-Code H.S. Key Machine	170239001

The Tri-Code H.S. Key Machine comes with a 3 year warranty against factory defects only. This warranty does not cover the vices or the cutting wheel.

040 MANUAL / AUTOMATIC KEY MACHINE

- This key machine is an automatic/manual function machine designed to be operated as either an automatic or manual type duplicator. The 040 accepts longer length keys and those with oversize heads.
- Equipped with Super Jaw 2 , four-way vises, grips virtually any cylinder key without the need for adapters. Offset carriage allows for gauging keys from the tips where necessary.

NEW Features

- Dial type depth adjustment system greatly simplifies calibration and improves accuracy
- Machine cover is constructed of high strength, impact resistant material
- Dual function - Operate in Automatic mode for convenience or Manual mode for special situations
- Designed to duplicate virtually all cylinder keys on the market
- New design permits cutting of large bow/long blade keys
- Vise jaws will securely clamp most cylinder keys without adapters
- Great for double-sided automotive keys
- Features a "Soft Touch" deburring brush for deburring cut keys safety
- Cutting cycle is 18 seconds
- Easy to operate... a real money maker
- Meets OSHA and CSA/NRTL.C* requirements



Description	Art #
040 Manual / Automatic Key Machine	170237000

The 040 Manual/Automatic Key Machine comes with a 1 year warranty against factory defects only. This warranty does not cover the vices or the cutting wheels.

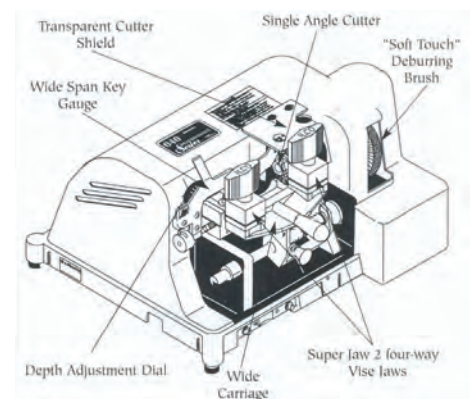
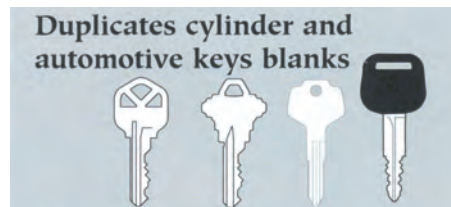

HAND-HELD KEY MACHINE

- The WURTH Hand-Held Key Machine is compact, lightweight and easy to operate
- Safety Shield to deflect chips downward and away
- Constructed of Steel, Brass, and Anodized Aluminum Alloy
- The Lower Vise is made from Stainless Steel
- Saves considerable \$\$ for users with numerous applications
- 100% American made

Features

- Quickchange Kits
- Complete, self contained kits
- Interchangeable Punch & Die.
- Depth Knob
- Modular Construction with sturdy ergonomic grip
- Backed by complete WURTH Warranty 90 Day Manufacturer's Defect Only

Benefits

- Greater precision.
- Quicker changeover.
- No searching for individual components.
- No need for multiple machines.
- Less wear than cam sets.
- Minimizes wear.
- Broaden applications as needed with less outlay of expense.
- Drastically reduces down time



Description	Art #
Gun with 90T punch	071579500
Gun with 88T punch	071579600

Punch and Die Sets



Description	Art #
90T punch (drop ship)	0715790085
88T punch (punch only)	0715790086

Quickchange Kits available separately.

WURTH BENCH MOUNT FOR HAND-HELD KEY MACHINE

WURTH's Bench Mount may be used with all PAK-A-PUNCH models. Simply remove the existing pivot handle, insert the machine into our Bench Mount and you'll be cutting keys with less effort than ever before. Use on the new "Z" keyway Key blanks.



Bench Mount shown with Key Machine

Description	Art #
Bench Mount	171579550

Compare WURTH to Other Hand-Held Machines

Features	WURTH Hand-Held Key Machine	Other Hand-held Key Machines
Modular Construction	YES!	NO
Depth Adjustments	Depth knob for accuracy and longevity	Cam set for convenience but less tolerance and durability
Service	Complete service	Expensive service calls
Punch and Dies	Interchangeable punch and dies - one machine does it all!	Could need as many as 5 different carriages and cams to punch for 1 manufacturer
Versatility / Ease of Use	Quickchange kits - Quicker changeover	Grid system - purchase separate components as necessary
Components	All necessary components are in each kit	Cumbersome and awkward
Operation	Single action	Double action

KEY MACHINE QUICK REFERENCE GUIDE

Vice	Required Punch and Die	Manufacturer and Application	Art #
A02	90°-T	"AMC, Jeep, Mack '7-/Up"	0715 79824 (D.S.)
C04	88°-T	Buick/Hyundai/Isuzu/Mitsubishi/	0715 79815
VOK	90°-T	Volkswagen	0715 79825
HY12	88°-T	Kia Optima / Plymouth/Suzuki/Dodge '70/Up	0715 79845
G03	88°-T	"Cadillac Catera, Pontiac Lemans,"	0715 79831 (D.S.)
G05	88°-T	Chevy/Geo/GMC/Isuzu '85/Up	0715 79816 (D.S.)
C05	90°-T	Chrysler '98 M Series (8 cut)	0715 79834
C01	90°-T	Chrysler Corp. (5 cut)	0715 79800 (D.S.)
C03	90°-T	Chrysler Corp. (7 cut)	0715 79801 (D.S.)
C02	90°-T	Chrysler Corp. '93 - '97 (7 cut)	0715 79804
G04	88°-T	Chrysler/Mitsubishi/Geo - Isuzu/Hondas'90/up	0715 79808
DW2	88°-T	Daewoo Leganza	0715 79844 (D.S.)
DW1	88°-T	Daewoo Nubira & Lanos	0715 79843 (D.S.)
F01	90°-T	Ford (10 Cut)	0715 79802
F03	90°-T	Ford 8-Cut (PATS Key)	0715 79827
F02	88°-T	Ford Aspire '94/Up	0715 79826 (D.S.)
FO6	88°-T	Ford Escort, Probe and Tracer '97 - '99	0715 79832 (D.S.)
MZ1	88°-T	Ford/Mazda's '92/Up	0715 79811 (D.S.)
MZ2	90°-T	Ford/Mercury/Mazda's '83-'93, Ford Probe and Festiva	0715 79812 (D.S.)
G06	88°-T	Geo/Isuzu/Suzuki/Honda '89/Up	0715 79817
G01	90°-T	GM (6 & 10 Cut)	0715 79803
G11	90°-T	GM (Saturn) '91 - '96	0715 79806 (D.S.)
G02	90°-T	GM "J" & "N" Body Cavalier/Grand Am '91 - '94	0715 79807 (D.S.)
H01, H02, H03	88°-T	Honda/Acura Kit (includes 3 vises) / Early and late model Honda plus some Acura	0715 79819 (D.S.)
F4	90°-T	Hummer & Ford (includes 2 vises),(ignition & door/trunk - 5 Cut)	0715 79805 (D.S.)
N1,N2,N3	88°-T	"Infiniti, Nissan/Subaru Kit (includes 3 vises)	0715 79818 (D.S.)
H01	88°-T	Isuzu Trooper/Rodeo 5001-8442 code series	0715 79835 (D.S.)
KA1	88°-T	KIA Before '98	0715 79833 (D.S.)
KA2	88°-T	KIA Sephia '98/up	0715 79836 (D.S.)
LR1	88°-T	Landrovers '87/Up and Sterling	0715 79840
MT1	88°-T	Mitsubishi Galant '99/Up F0001-1571 code series	0715 79842
HY1	88°-T	Mitsubishi Precis & Hyundai '86 - '95	0715 79830 (D.S.)
N04	88°-T	Nissan Pathfinder & Altima / Infinity Q45, QX4/Subaru Forester '97/Up	0715 79828
A01	90°-T	Peterbilt, Kenworth & other Trucks '66/Up	0715 79823 (D.S.)
G14	90°-T	Saturn '97/Up & Isuzu, Hombre 96/UP, GM10CUT	0715 79841
T04	88°-T	Toyota Camry, Cressida, Corona '72 - '91 / Chevy Nova '86 - '88	0715 79814 (D.S.)
T06	88°-T	Toyota Cressida '78 - '87	0715 79822 (D.S.)
T01, T02, T03, T04, T05, T06	88°-T	Toyota Kit (includes 6 vises)	0715 79820 (D.S.)
T05	88°-T	Toyota Paseo, Previa Van, Tercel '87/Up	0715 79821 (D.S.)
T03	88°-T	Toyota's '70 - '90, Hino up to '89	0715 79813 (D.S.)

KEY MACHINE QUICK REFERENCE GUIDE (CONTINUED)

Vice	Required Punch and Die	Manufacturer and Application	Art #
T02	88°-T	Toyota's '88/Up, Geo Prizm '89 - '92	0715 79809 (D.S.)
T01	88°-T	Toyota's '92/Up, Geo Prizm '93/Up	0715 79810
VL1	90°-T	Volvo's 240/740/780 '78 - '93	0715 79829 (D.S.)
T07	88°-T	Toyota Codes 5001-69999	71579846
G15	90°-T	Chevy Malibu, Pontiac Grand Prix & GM Z Keyway	71579847
G16	60°-T	Chevy Colorado, Chevy Malibu & GMC Canyon '04 & up	71579848
HY2	88°-T	Hyundai Sonata	71579849
HY3	88°-T	Hyundai / Mitsubishi	71579449

DS = Drop Shipped

DISPOSABLE KEY TAGS



- Made of laminated paper
- Eliminates having piles of keys to sort
- Gives a shop a professional look and saves valuable time for other duties
- Pliable and easy to write on
- Will accept pen or felt marker
- 100 per pack

Description	Art #
Disposable Key Tags	1791100

PAGE SET UP

- The manufacturer's name appears above the key blank drawings.
- The ILCO number appears below each key. Vehicle section references the EZ numbers below the ILCO number.
- International Cylinder section references Silca and Orion key blank numbers below the ILCO number.
- Key drawings may also show important information such as number of pins, the presence of a transponder in the head, etc.

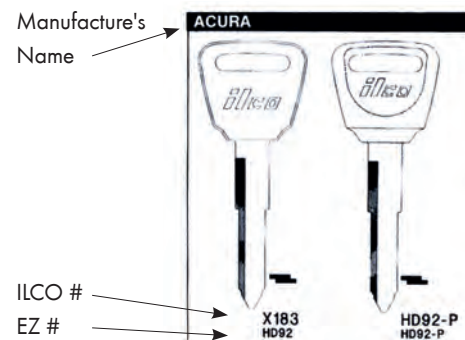

CHECKING MILLING PROFILES

To check the milling profile, hold the key blank by the head and place the tip of the key over the milling profile. Look straight down, check both sides of the milling profile to be certain of a match.



ACURA

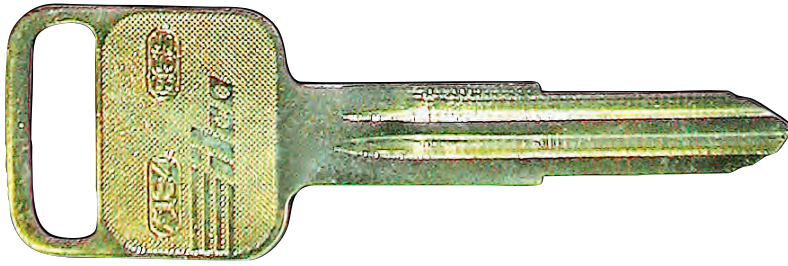

HD 103
1791181605
 Non OEM

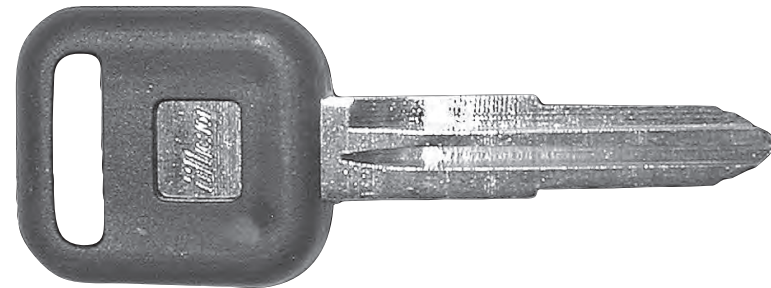

HD103P
1791181636
 Non OEM

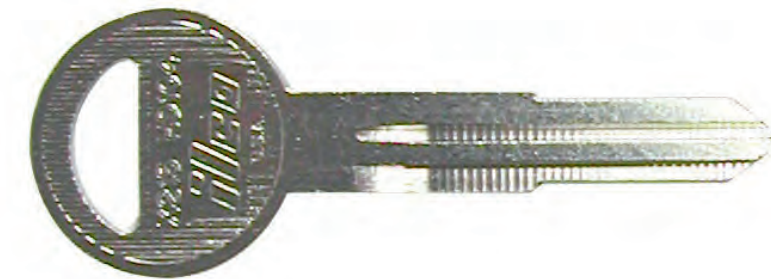

HD104
1791169993
 Non OEM

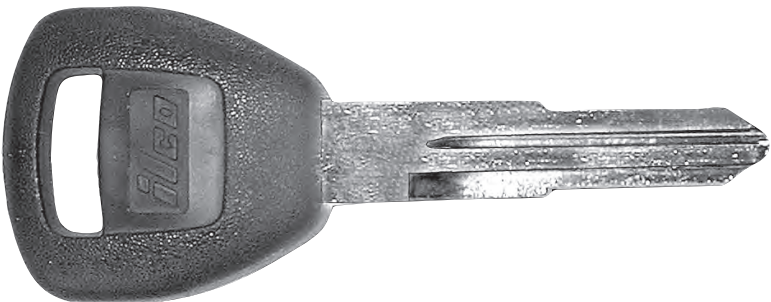

HD 106 PT
1791 206353
 Transponder
Requires RW2 or Requires SDD
 Non OEM

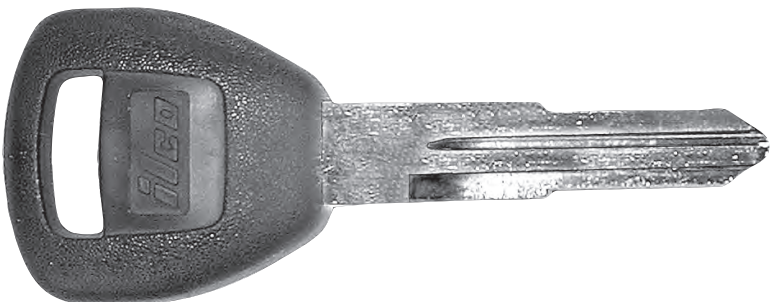

HD 106 PT 5
1791182169
 Transponder
Requires RW2
 Non OEM



© 2011 WÜRTH USA, Inc. Revision 03/2011

AMC



RA4
17913602
 Non OEM

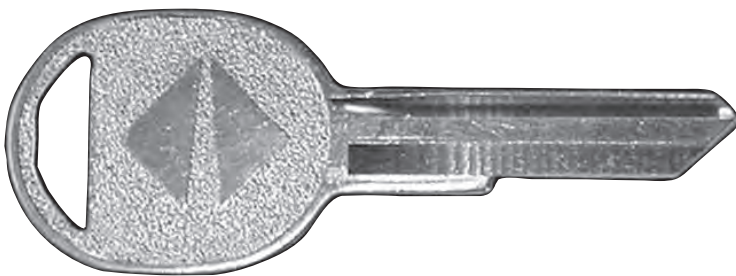

RA3
17913601
 Non OEM

AUDI

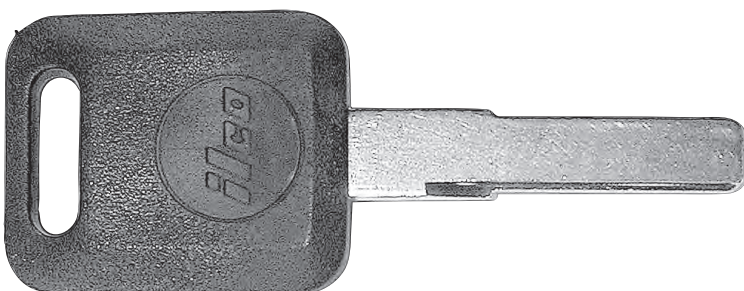

HU66A-P
1791193905
High Security
 Non OEM

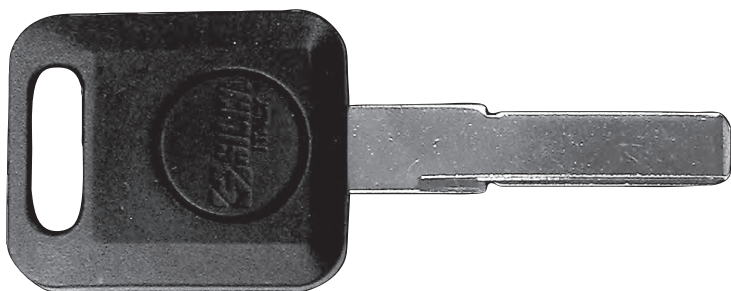

HU66AT6
1791196159
Requires SDD
High Security
Transponder
 Non OEM



BMW

BMW3
1791133765
Non OEM



S7BW
179134175
High Security
Non OEM

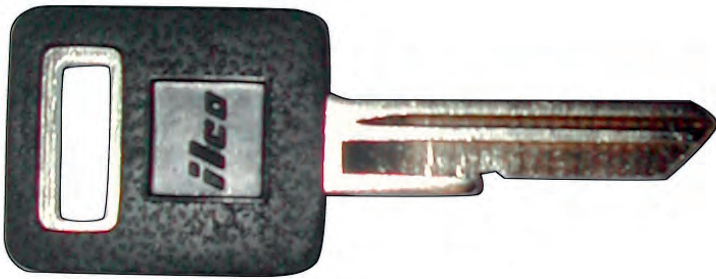

BUICK

B44P
17913025
Non OEM

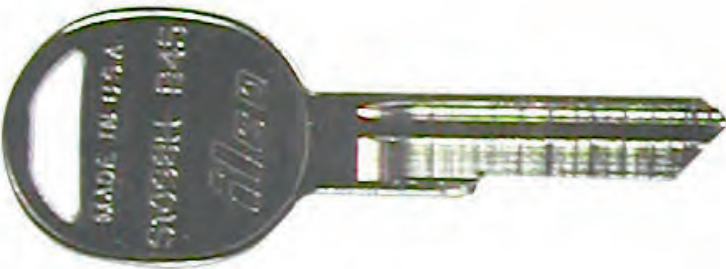

B45
1791100095
Non OEM

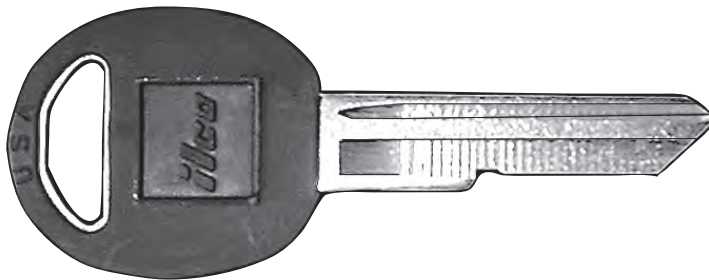

B45P
1791167364
Non OEM



B45GP
17913024
H-Keyway
OEM



BUICK (CONTINUED)

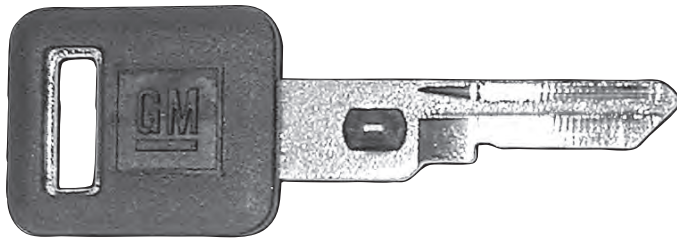

B62
OEM Pass Vats
Single Sided

Key #	OEM Art #	Key #	OEM Art #
1	17912001	9	17912009
2	17912002	10	17912010
3	17912003	11	17912011
4	17912004	12	17912012
5	17912005	13	17912013
6	17912006	14	17912014
7	17912007	15	17912015
8	17912008		



B79
1791167807
Non OEM

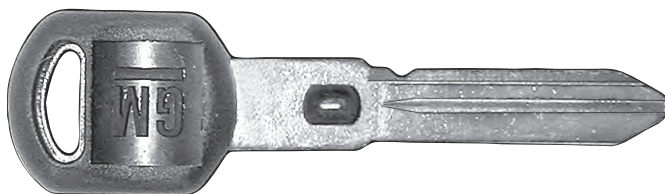

B82
OEM Pass Vats
Double Sided

Key #	OEM Art #	Key #	OEM Art #
2	17912016	9	17912023
3	17912017	10	17912024
4	17912018	11	17912025
5	17912019	12	17912026
6	17912020	13	17912027
7	17912021	14	17912028
8	17912022	15	17912029

Can be substituted for Corvette Vats

BUICK (CONTINUED)

B84
1791174256
Non OEM

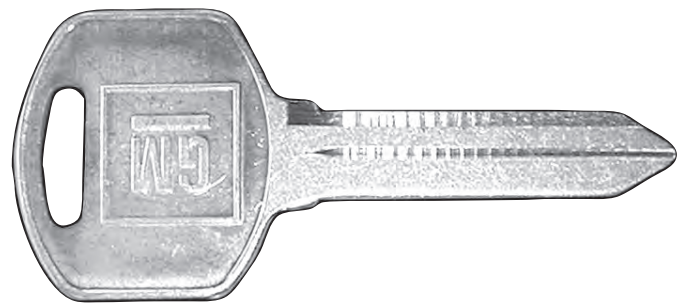

B85
17913042
OEM



B86
1791179398
Non OEM

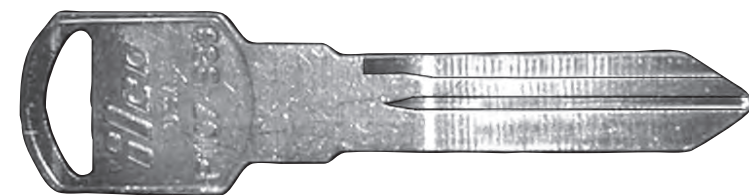

B89
1791179794
Non OEM



B89P
1791179824
Non OEM



BUICK (CONTINUED)

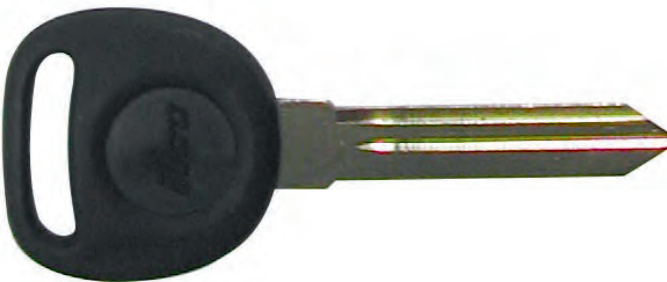

B97PT
1791182596
 Non OEM



B99PT
1791191710
 OBP Program
 Non OEM

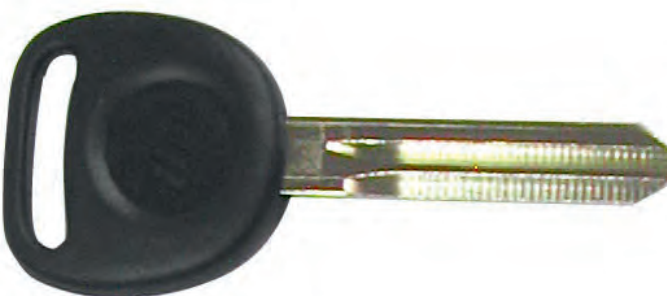

B99PT5
1791195251
Transponder
 Non OEM



B106P
1791202348
 Non OEM

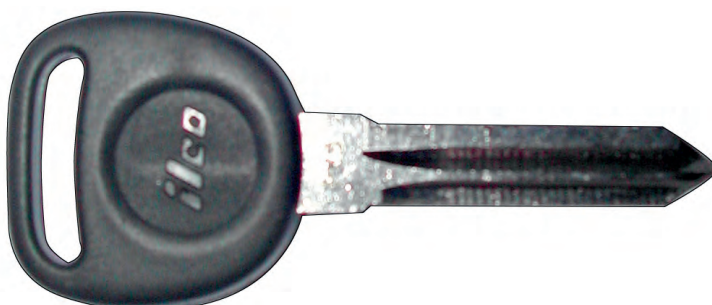

PTO4PT
1791206544
 OBP Program
Transponder
 OEM

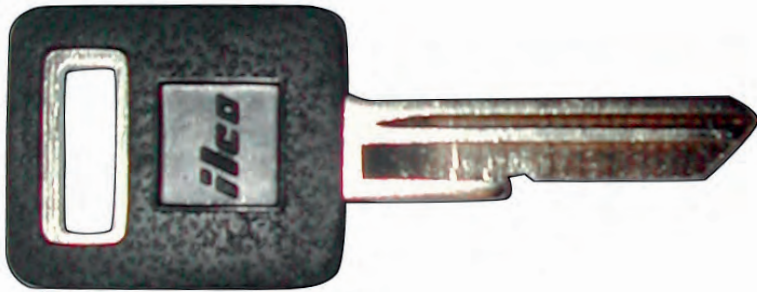

CADILLAC

B44P
17913025
 Non OEM



B45
1791100095
 Non OEM

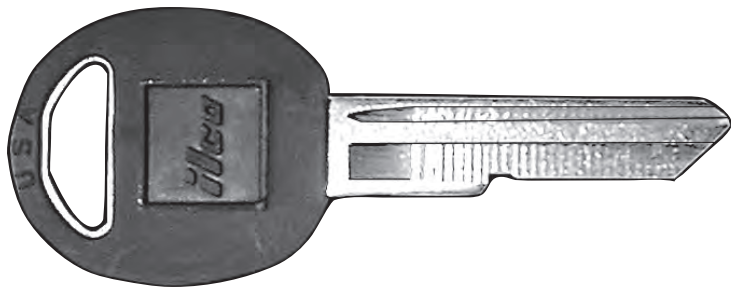

B45P
1791167364
 Non OEM

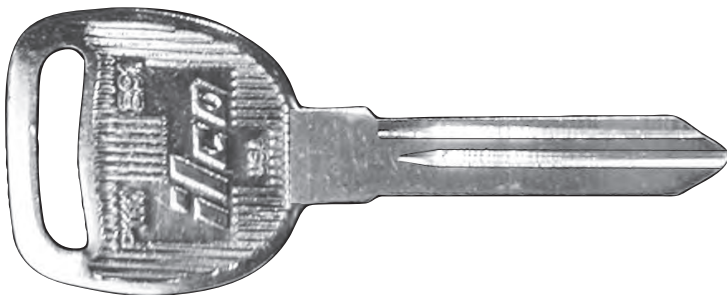

B91
1791182145
 Non OEM

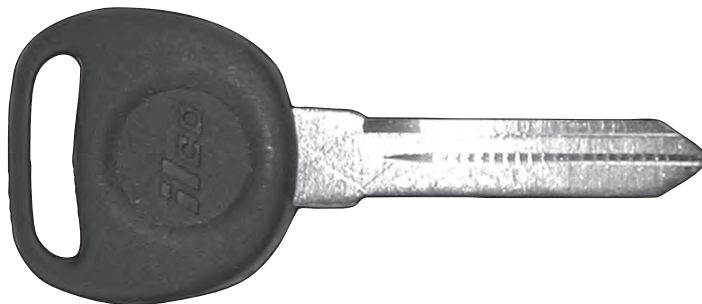

B91P
1791182152
 Non OEM



CADILLAC (CONTINUED)

B99PT5
1791195251
Requires RW2
High Security
Transponder
 Non OEM

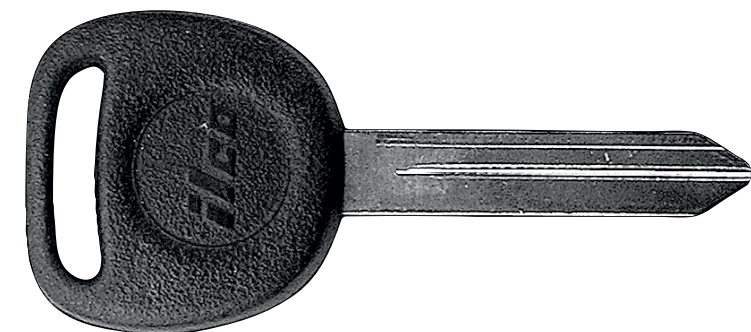

B102P
1791195275
 Non OEM

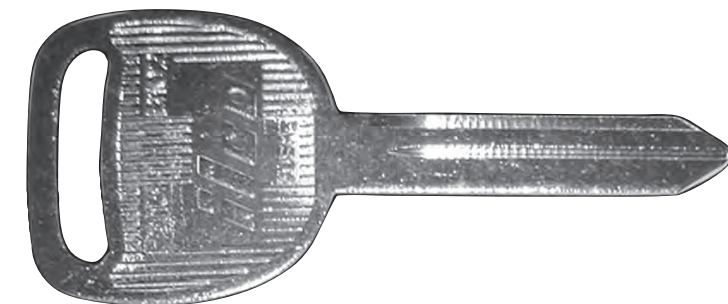

B102
1791195299
 Non OEM



GMT265
 B111PT
17913265
Transponder
 OEM

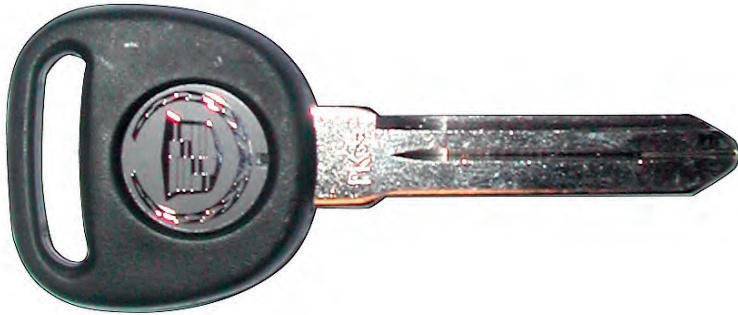

CADILLAC (CONTINUED)

GMX320
B99PT
1791 0320
Transponder
OEM

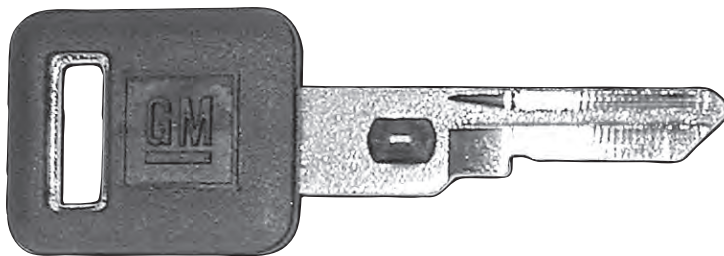

B62
OEM Pass Vats
Single Sided

Key #	OEM Art #	Key #	OEM Art #
1	17912001	9	17912009
2	17912002	10	17912010
3	17912003	11	17912011
4	17912004	12	17912012
5	17912005	13	17912013
6	17912006	14	17912014
7	17912007	15	17912015
8	17912008		



CHEVROLET

B44G
17913001
OEM

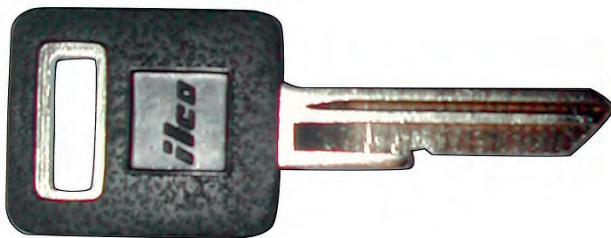

B44P
17913025
Non OEM

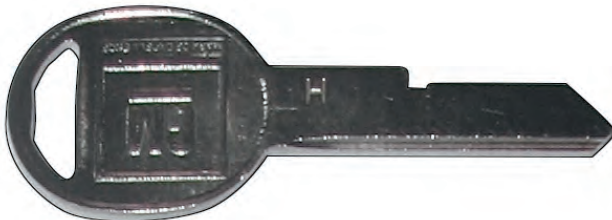

B45G
17913002
OEM

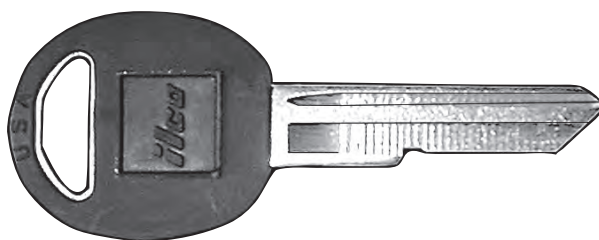

B45P
1791167364
Non OEM

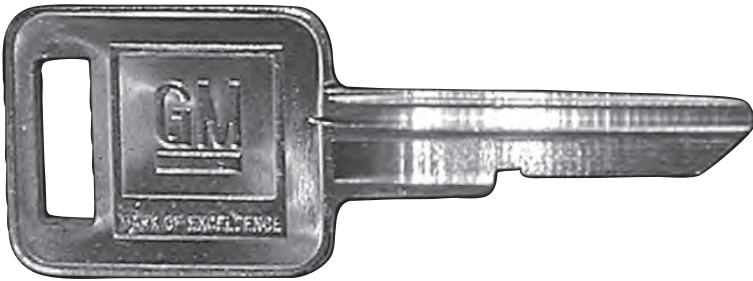

B45GP
17913024
H-Keyway
OEM

CHEVROLET (CONTINUED)

B46G
17913033
OEM

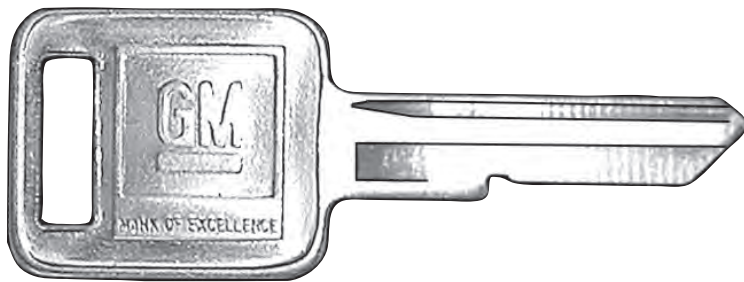

B48G
17913008
OEM



B49G
17913009
OEM



B50G
17913010
OEM

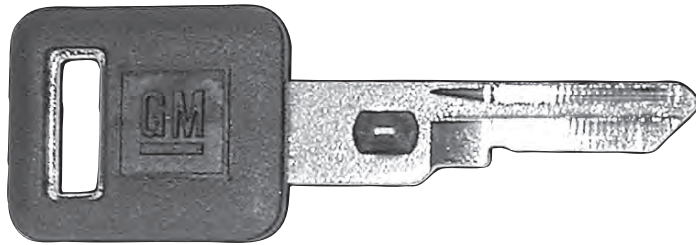

B51G
17913011
OEM

CHEVROLET (CONTINUED)

B62GP
OEM Pass Vats
Single Sided

Key #	OEM Art #	Key #	OEM Art #
1	17912001	9	17912009
2	17912002	10	17912010
3	17912003	11	17912011
4	17912004	12	17912012
5	17912005	13	17912013
6	17912006	14	17912014
7	17912007	15	17912015
8	17912008		



B63GP
17913021
OEM

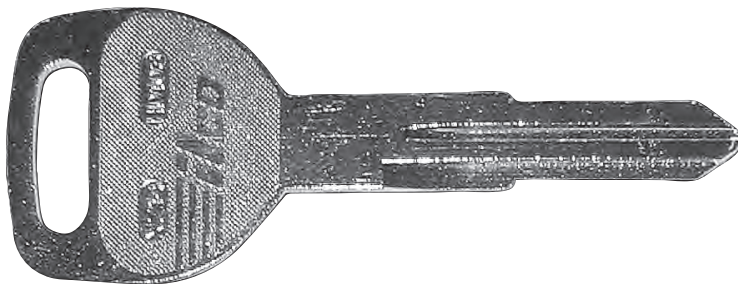

B65
1791181568
Non OEM

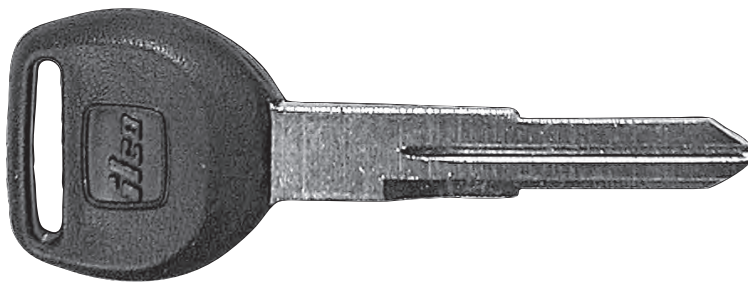

B65P
1791180547
Non OEM

CHEVROLET (CONTINUED)

B77GP
17913037
OEM



B79
1791167807
Non OEM

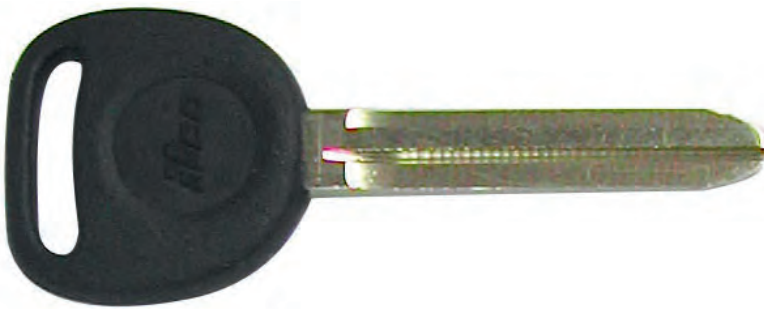

B79
1791167807
Non OEM



B79G
17913017
H-Keyway
OEM

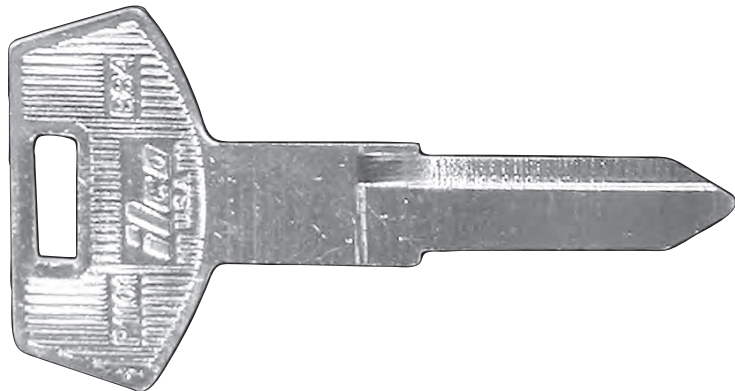

CHEVROLET (CONTINUED)

B84
1791174256
 Non OEM

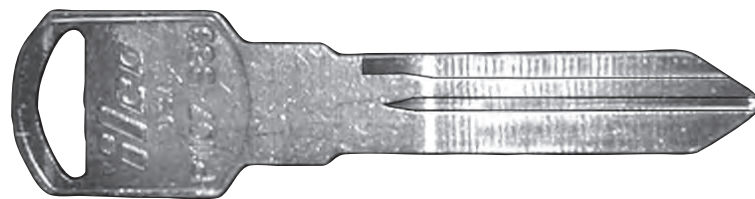

B89
1791179794
 Non OEM

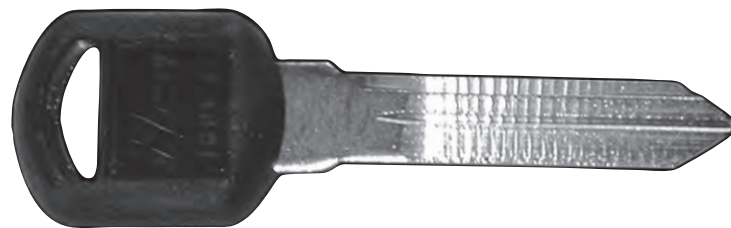

B89P
1791179824
 Non OEM

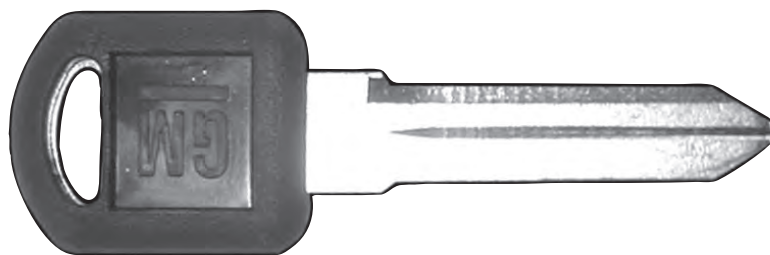

B89GP
17913030
 OEM

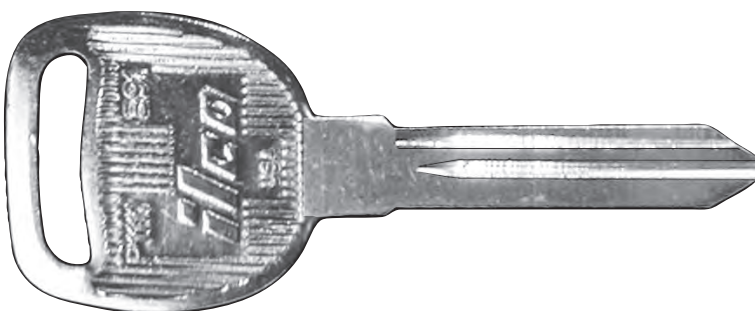

B91
1791182145
 Non OEM



CHEVROLET (CONTINUED)

B91P
1791182152
Non OEM



B91GCP
17913219
OEM

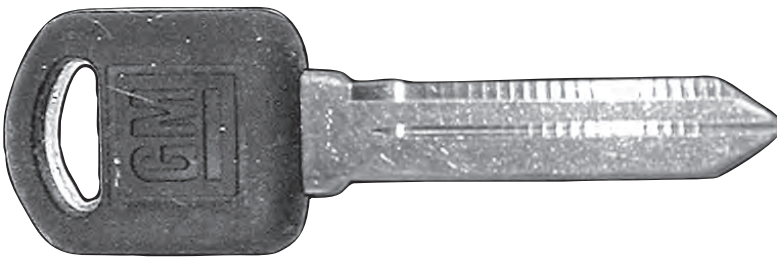

B97PT
1791182596
Transponder
or OBP
OEM

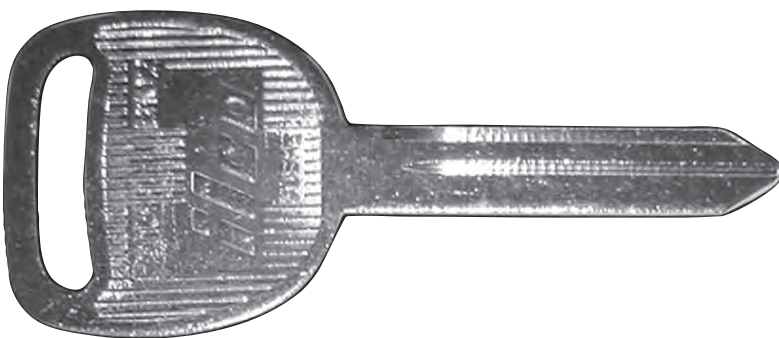

B102
1791195299
Non OEM

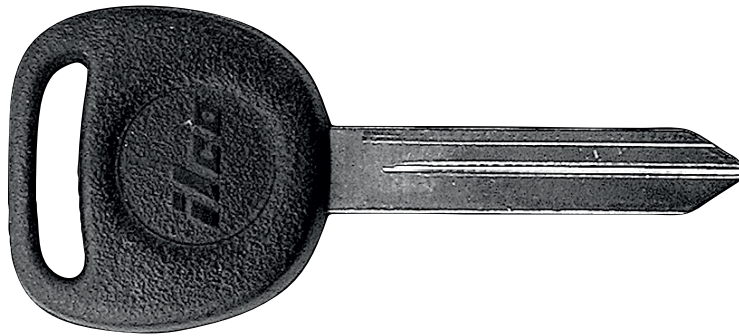

CEVROLET (CONTINUED)

B102P
1791195275
 Non OEM

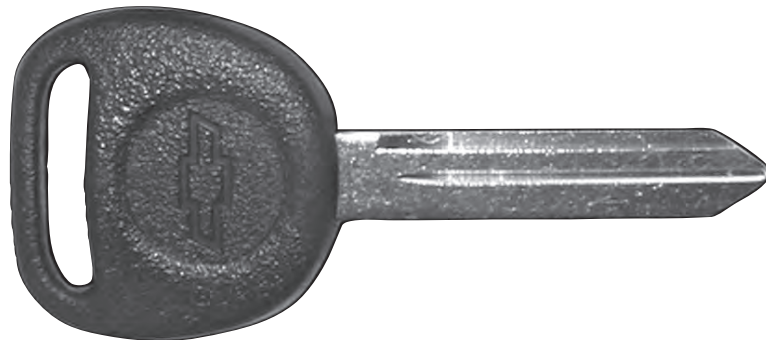

B102GCP
17913605
 OEM

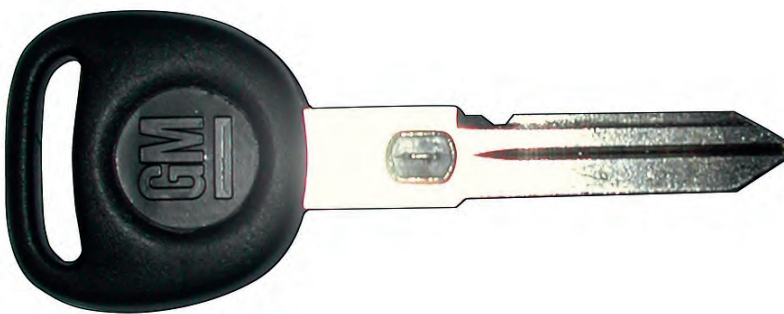

B104P
 Corvette Vats
 OEM

Key #	OEM Art #	Key #	OEM Art #
2	17919853	9	17919921
3	17919860	10	17919938
4	17919877	11	17919945
5	17919884	12	17919952
6	17919891	13	17919969
7	17919907	14	17919976
8	17919914	15	17919983

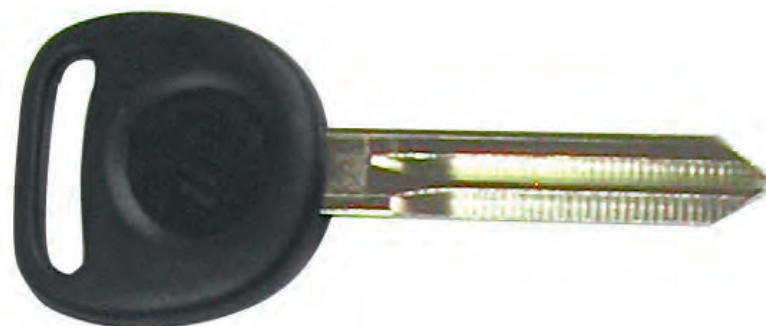

B106P
1791202348
 Non OEM

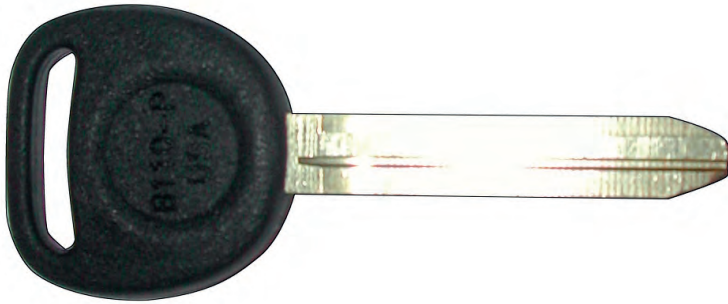
CHEVROLET (CONTINUED)

B110P
1791214044
Non OEM

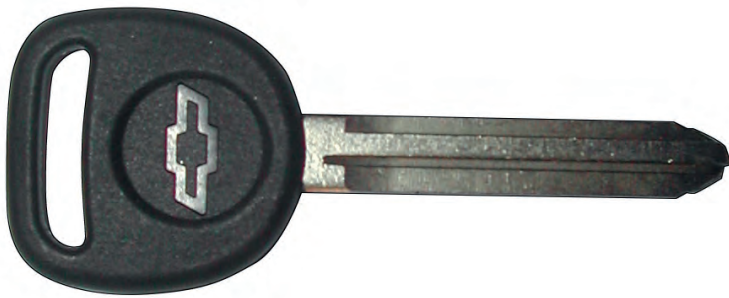

B110GCP
179116652
OEM

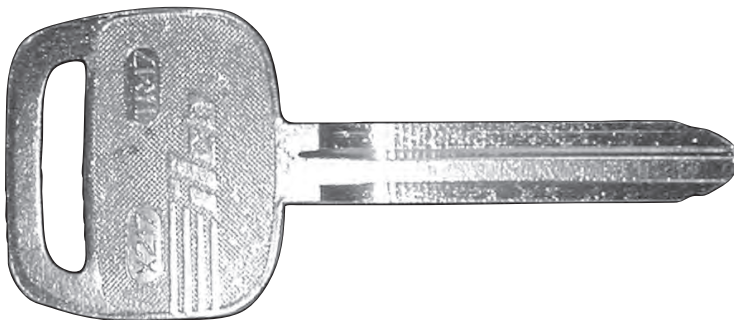

TR47
1791181551
Non OEM

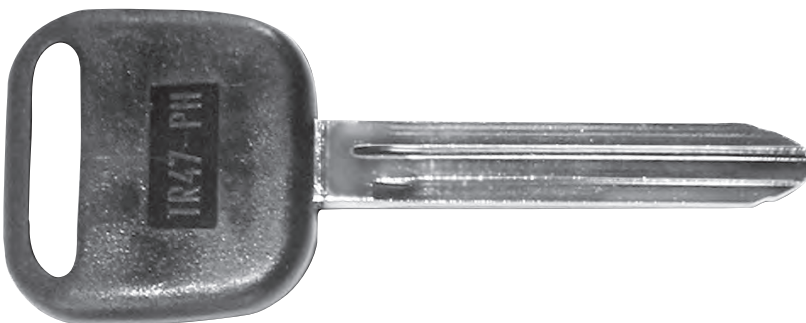

TR47P
1791181643
Non OEM

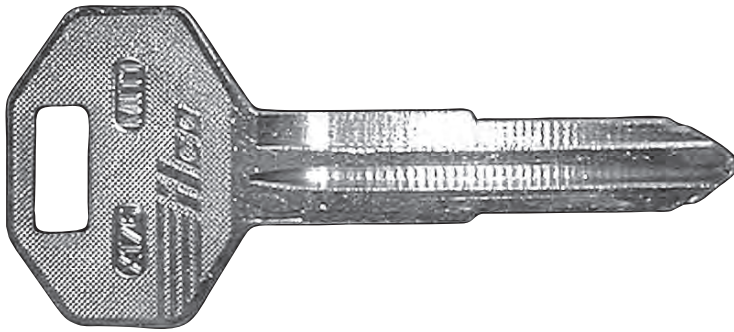
CHRYSLER

Mit1
1791181476
 Non OEM

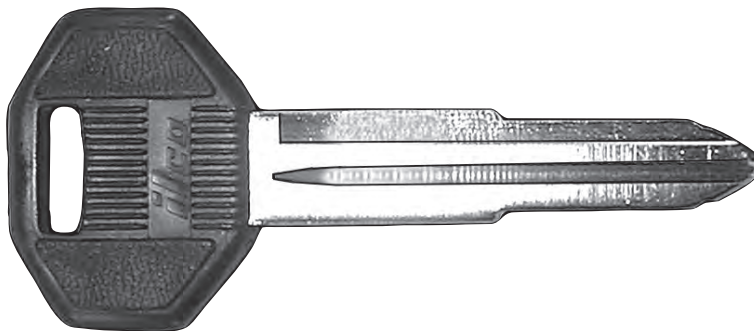

Mit1P
1791181629
 Non OEM

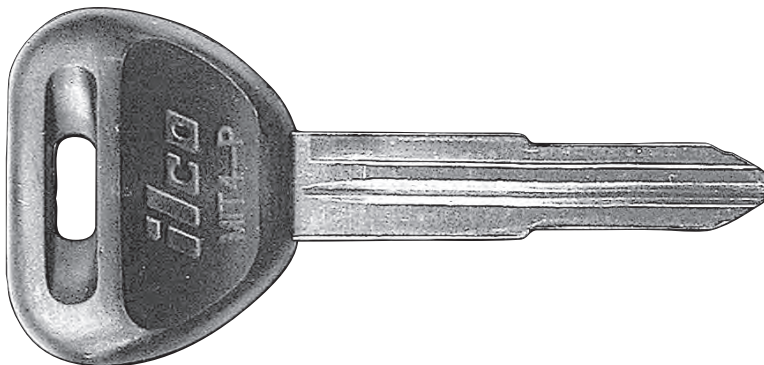

Mit4P
179118093
 Non OEM

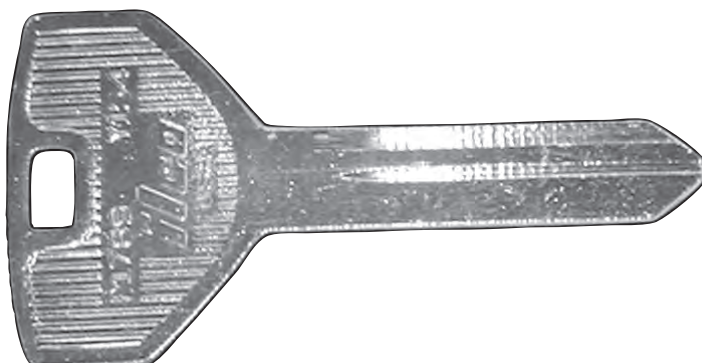

Y154
1791147632
 Non OEM

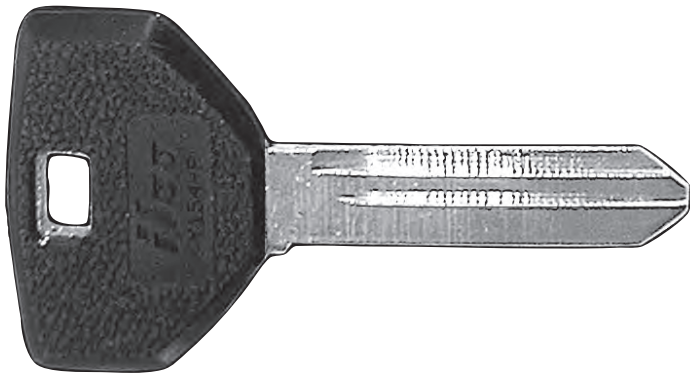
CHRYSLER (CONTINUED)

Y154P
1791134281
Non OEM

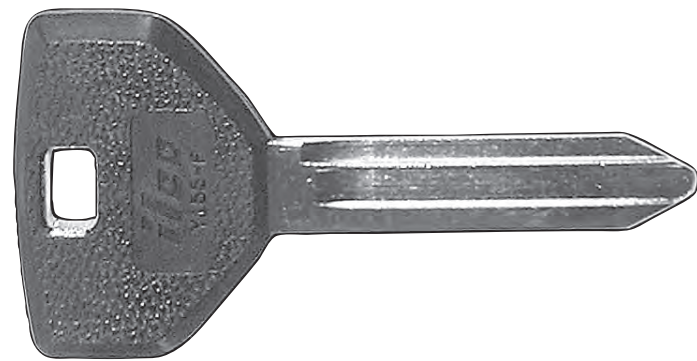

Y155P
1791173259
Non OEM

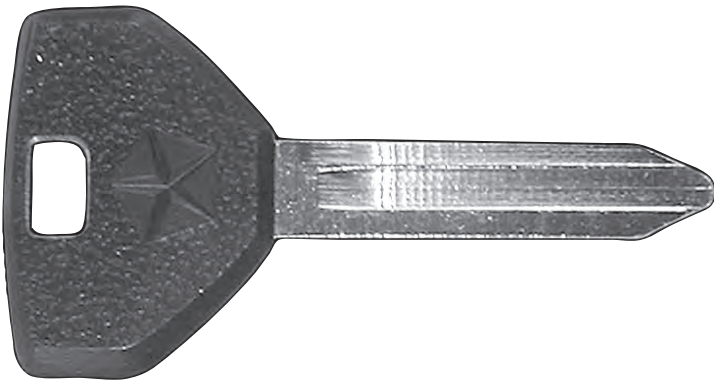

Y155PCHY
17913207
OEM

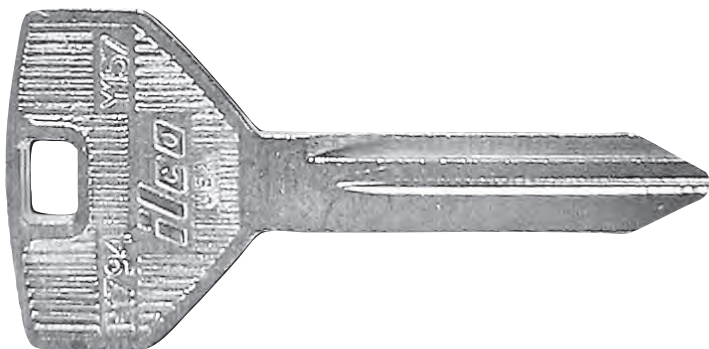

Y157
1791175710
Non OEM



CHRYSLER (CONTINUED)

Y157P
1791175727
 Non OEM



Y159
1791179077
 Non OEM



Y159CHY
17913211
 OEM



Y159P
1791179084
 Non OEM

CHRYSLER (CONTINUED)



Y159 CHRY-PH
17913212
OEM

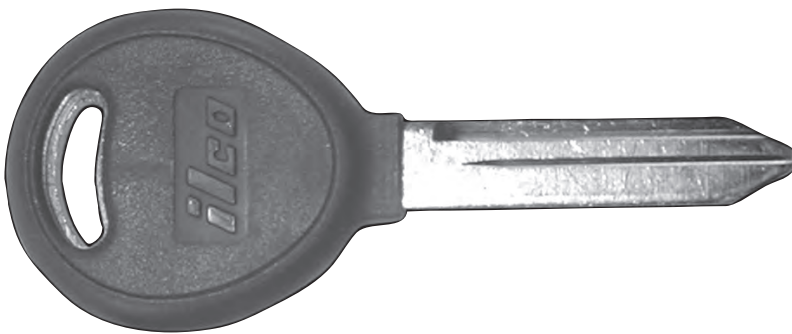

Y160PT
1791187164
Transponder
Requires SDD
or OBP
Non OEM



Y162PT
1791197675
Transponder
Requires SDD
Non OEM



DAEWOO

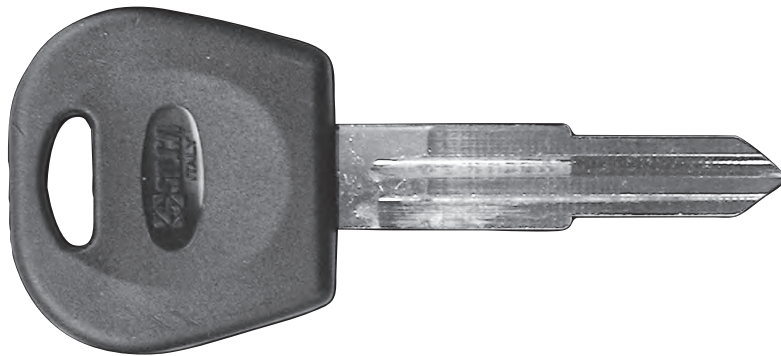

DW04RAP
1791196418
 Non OEM



DW04RT5
1791 196364
Transponder
Requires RW2
 Non OEM

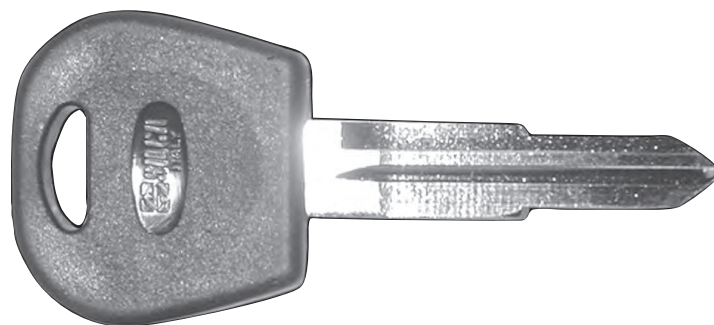

DW05AP
1791196395
 Non OEM

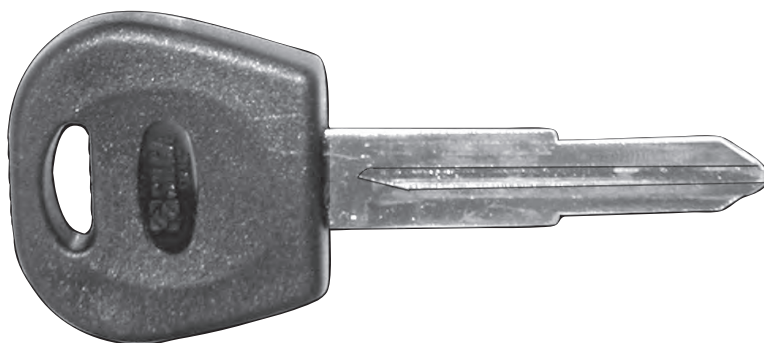

DW05RAP
1791196401
 Non OEM

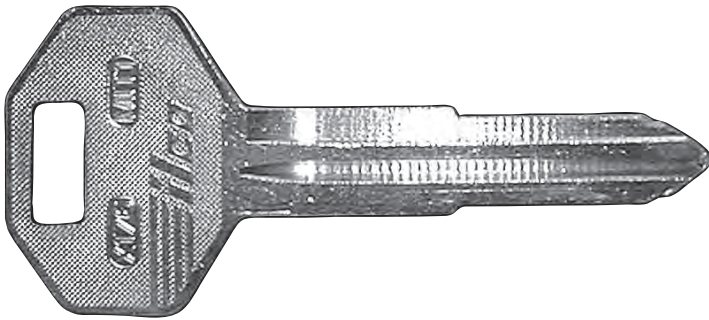
DODGE

Mit1
1791181476
Non OEM

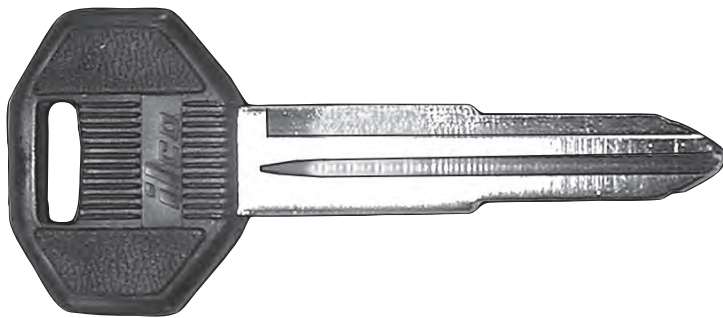

Mit1P
1791181629
Non OEM

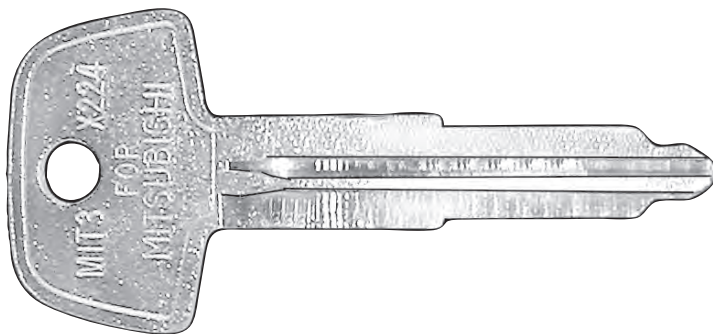

MIT3
1791173945
Non OEM

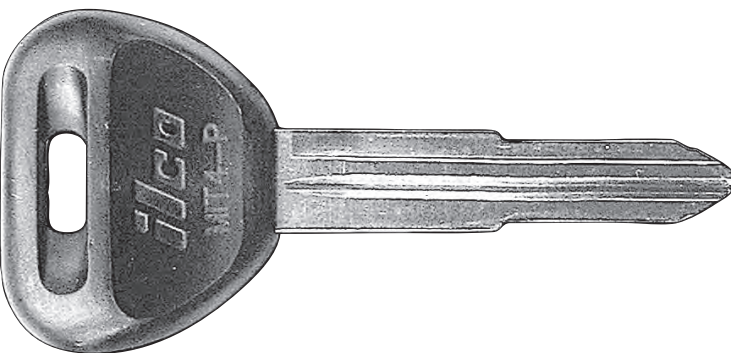

MIT4P
179118093
Non OEM

DODGE (CONTINUED)

MIT5
1791174638
Non OEM

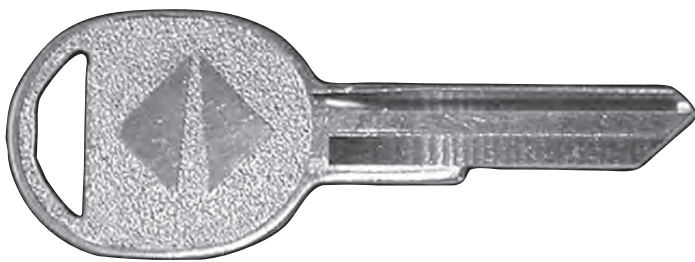

RA4
17913601
Non OEM

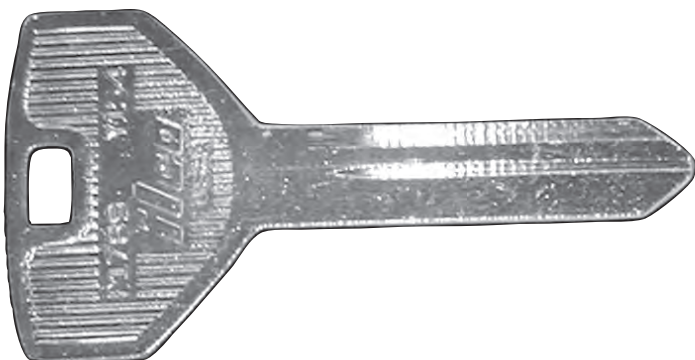

Y154
1791147632
Non OEM

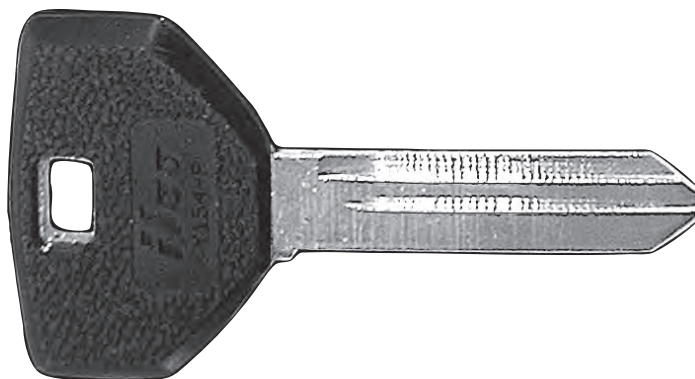

Y154P
1791134281
Non OEM

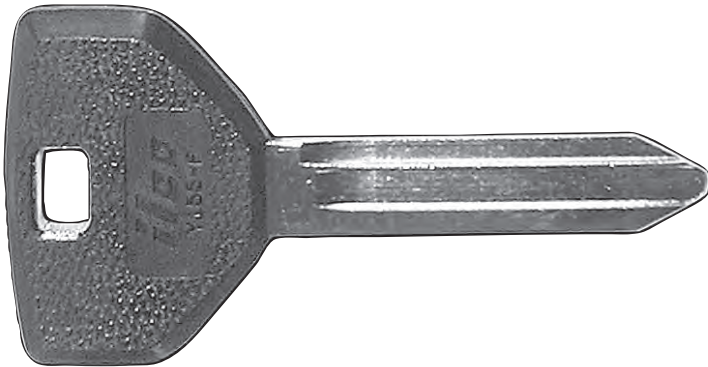

DODGE (CONTINUED)

Y155P
1791173259
Non OEM

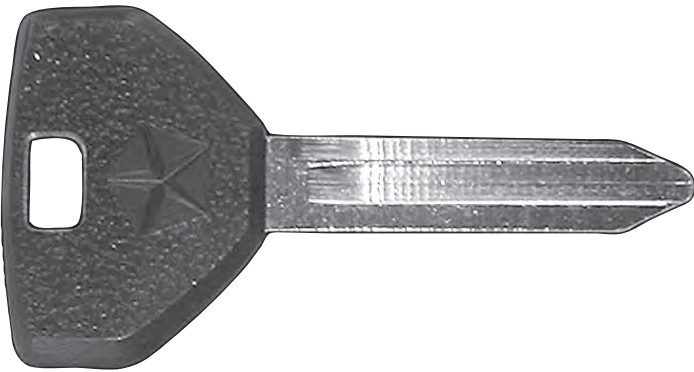

Y155PCHY
17913207
OEM

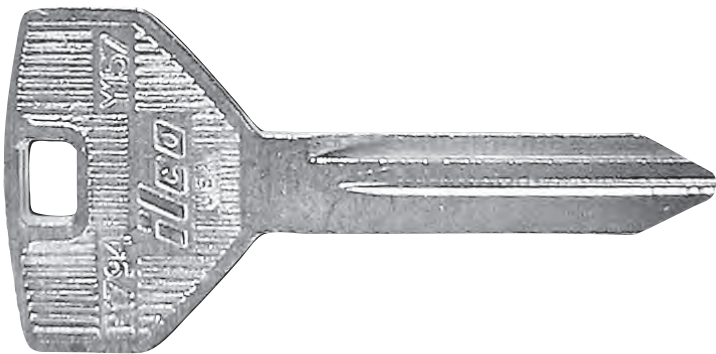

Y157
1791175710
Non OEM



Y157P
1791175727
Non OEM

DODGE (CONTINUED)



Y159
1791179077
 Non OEM



Y159P
1791179084
 Non OEM

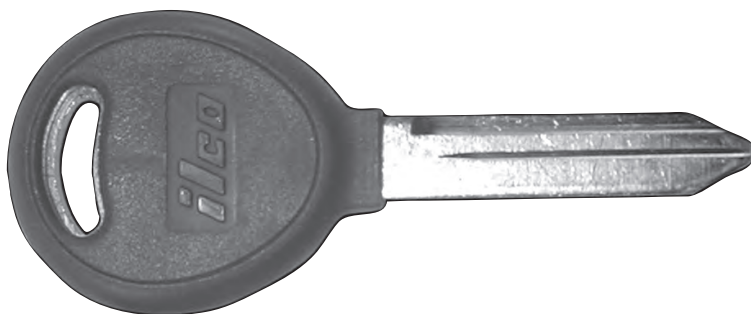

Y159P Ram
17913222
 OEM



Y160PT
1791 187164
Transponder
Requires SDD or OBP
 Non OEM

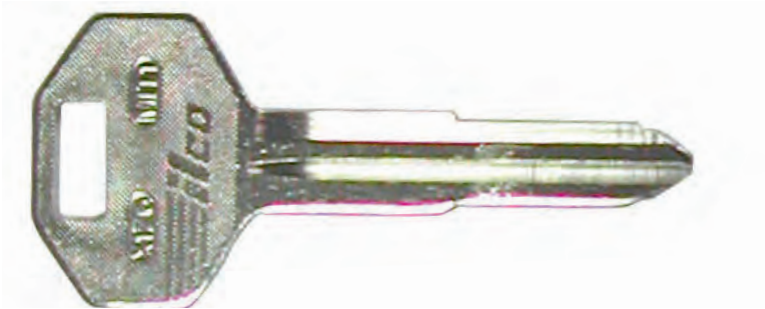

EAGLE

MIT1
1791181476
Non OEM

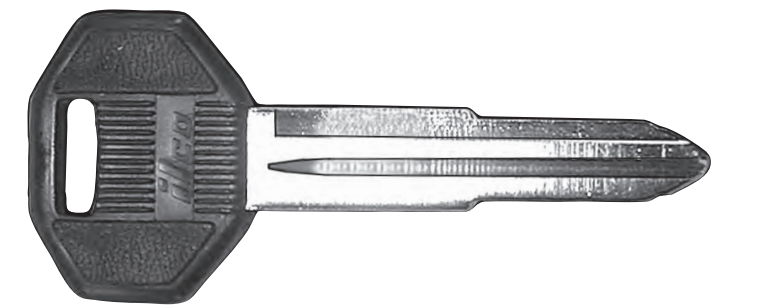

MIT1P
1791181629
Non OEM

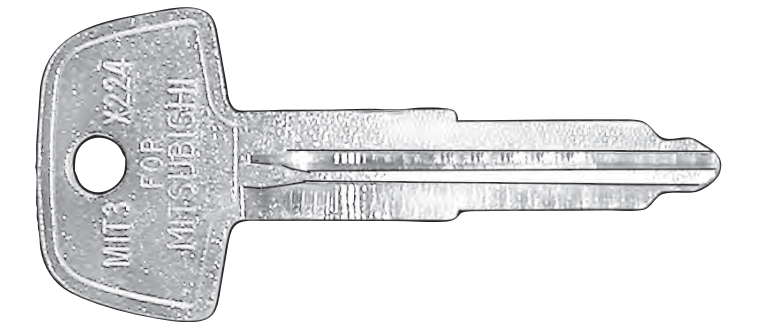

MIT3
1791173945
Non OEM

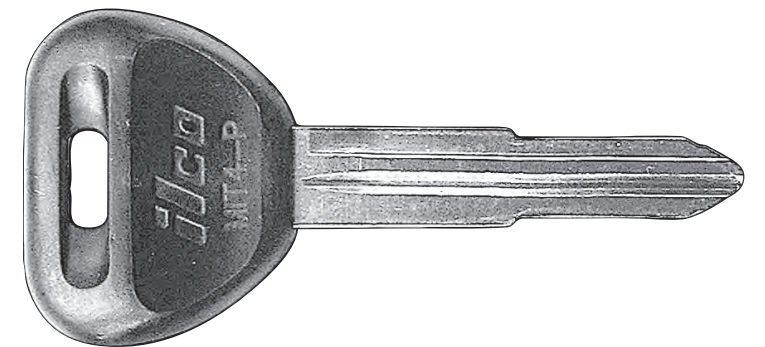

MIT4P
179118093
Non OEM

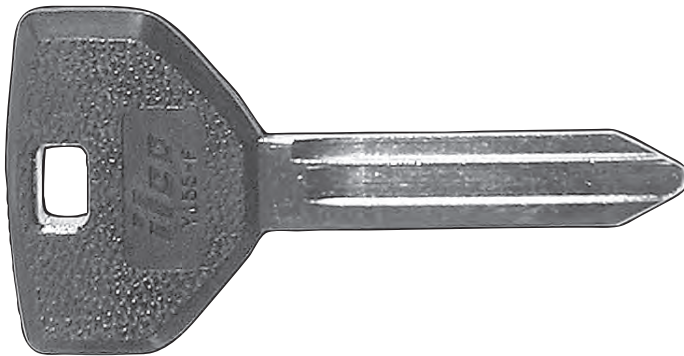

EAGLE (CONTINUED)

Y155P
1791173259
 Non OEM



Y157
1791175710
 Non OEM



Y157P
1791175727
 Non OEM



Y159P
1791179084
 Non OEM

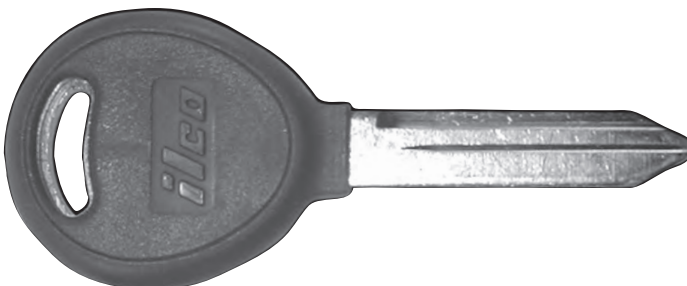

Y160PT
1791 187164
Transponder
Requires SDD
or OBP
 Non OEM

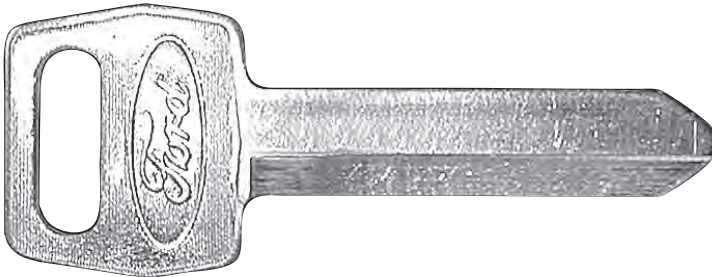

FORD

H51
17913102
 OEM

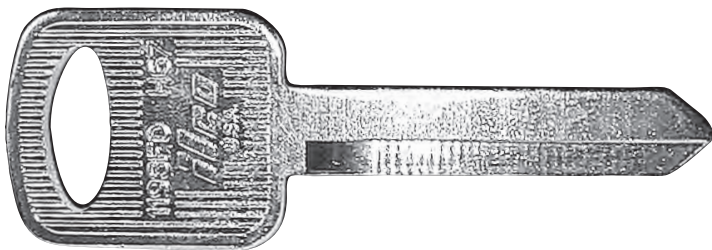

H67
1791171705
 Non OEM



H67P
1791171712
 10-Cut
 Non OEM



H67 PF
17918067
 OEM

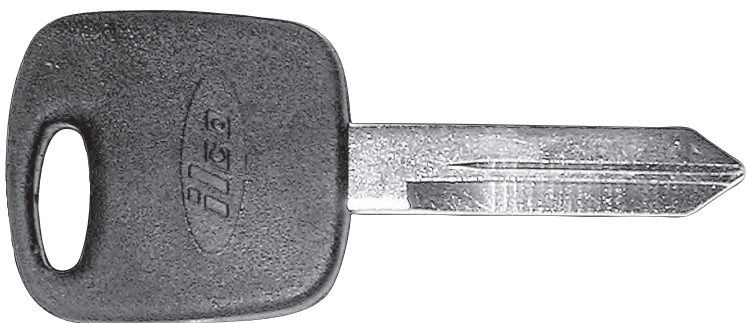

H72PT
1791 179459
Transponder
Requires SDD
or OBP
 Non OEM

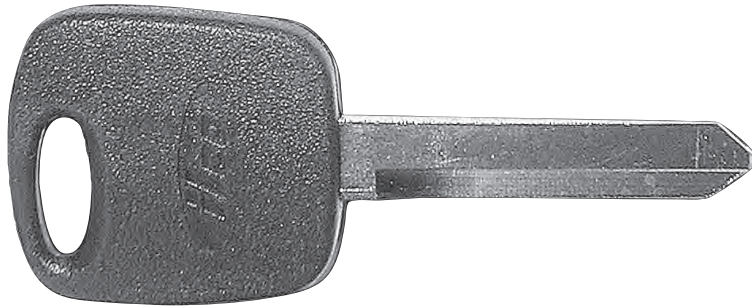

FORD (CONTINUED)

H73PT
1791 18004
Transponder
 Non OEM or OBP



H74PT
1791 2605
Transponder
Requires SDD
or OBP
 OEM

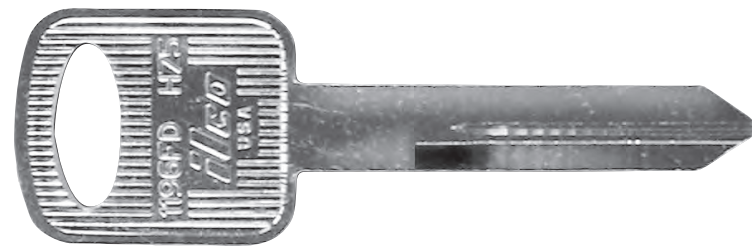

H75
1791180080
 Non OEM



H75PF
17918075
 8-Cut
 OEM

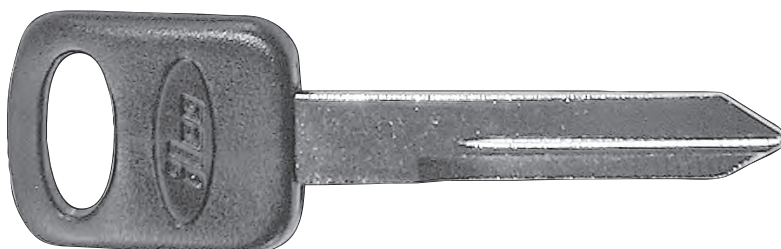

H75P
1791180097
 Non OEM

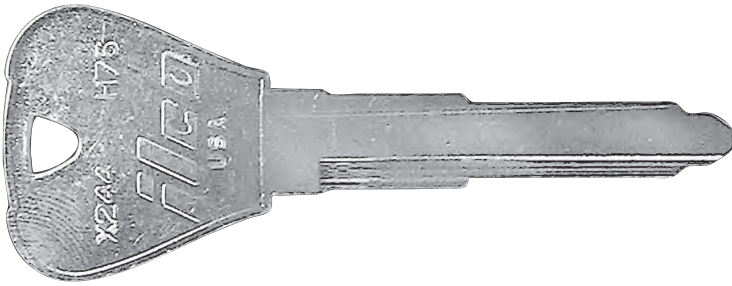

FORD (CONTINUED)

H76
1791181124
Non OEM

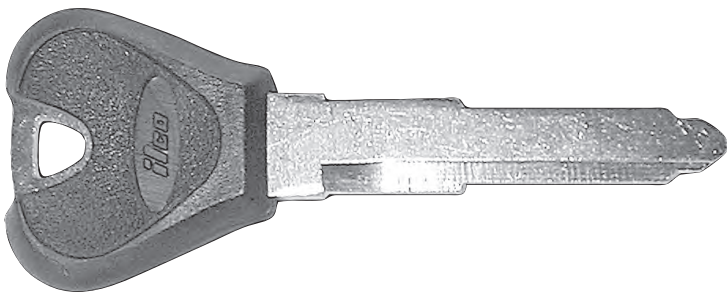

H76P
1791181094
Non OEM

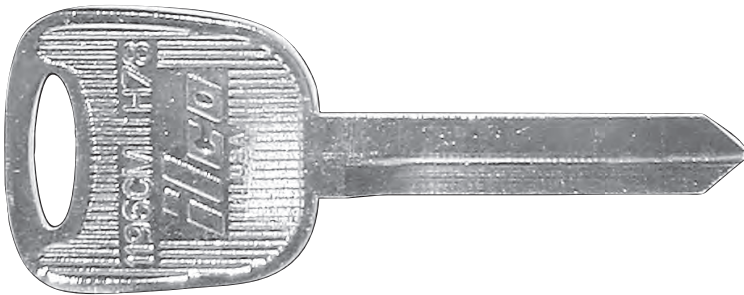

H78
1791181049
Non OEM



FORD (CONTINUED)

H86PT
17912609
Transponder
Requires SDD
or OBP
Non OEM

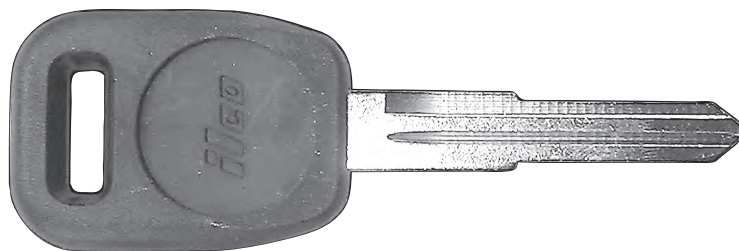

RV4P
1791180073
Non OEM

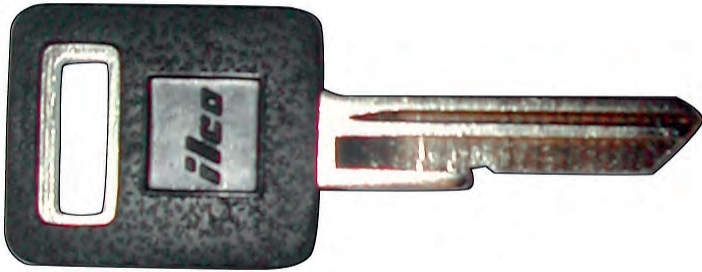

GMC TRUCK

B44P
17913025
OEM



B45
1791100095
Non OEM

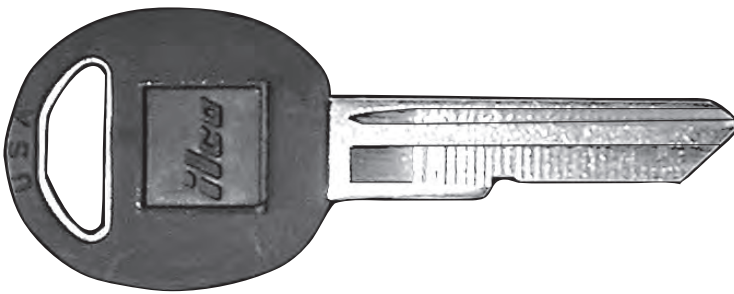

B45
1791167364
Non OEM



B45GP
17913024
H-Keyway
OEM

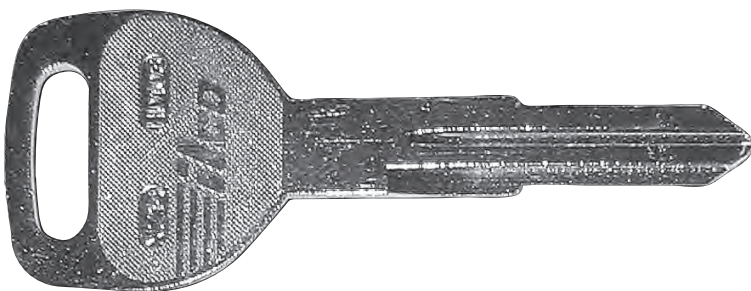

B65
1791181568
Non OEM

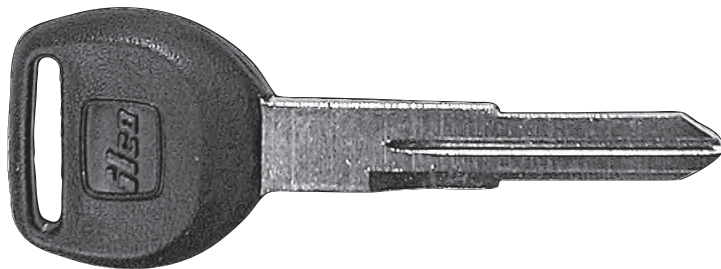

GMC TRUCK (CONTINUED)

B65P
1791 180547
 Non OEM



B89
1791179794
 Non OEM

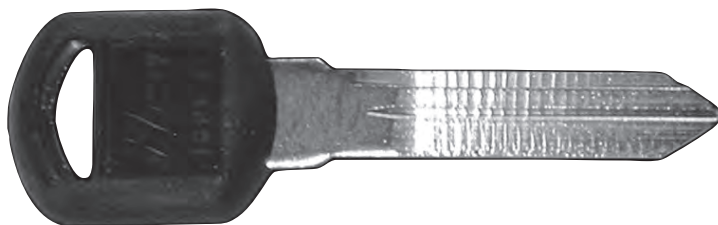

B89P
1791179824
 Non OEM

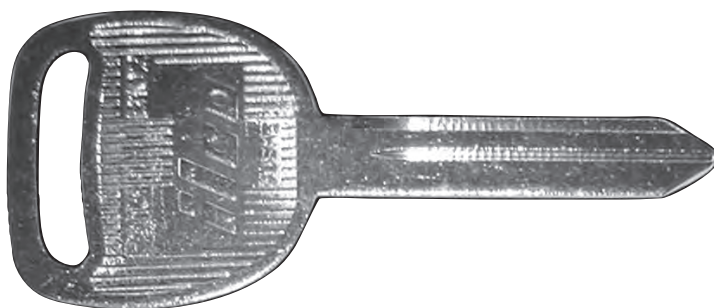

B102
1791195299
 Non OEM

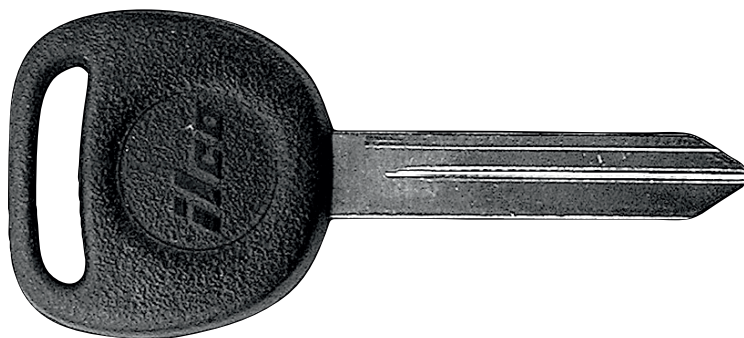

B102P
1791195275
 Non OEM

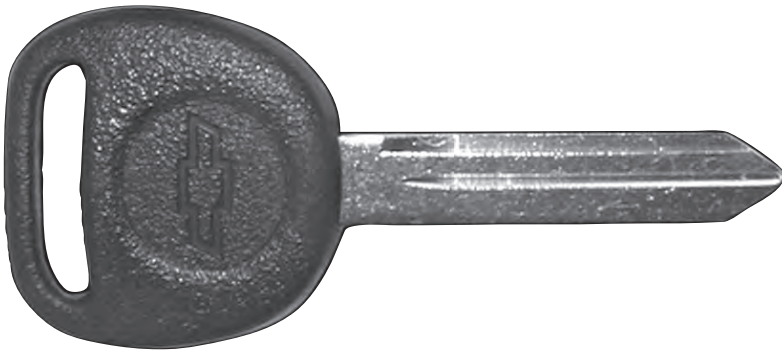

GMC TRUCK (CONTINUED)

B102GCP
17913605
OEM

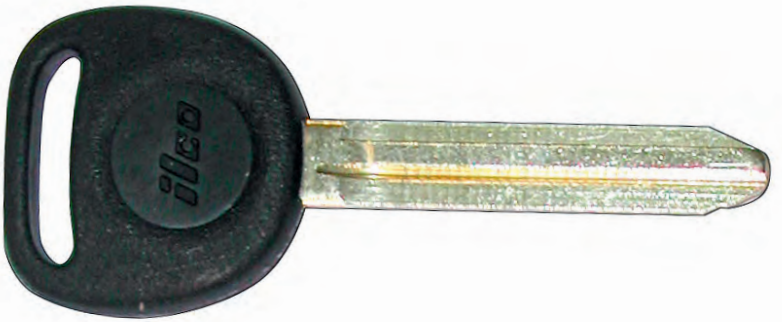

B110P
1791214044
Non OEM

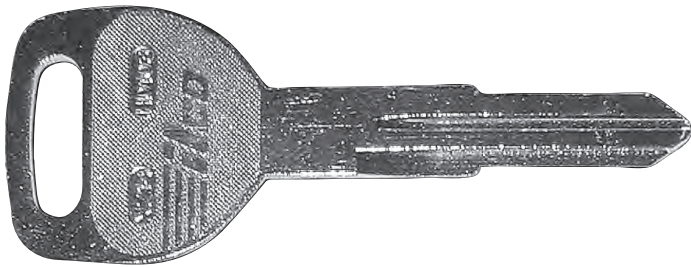

HONDA

B65
1791181568
 Non OEM

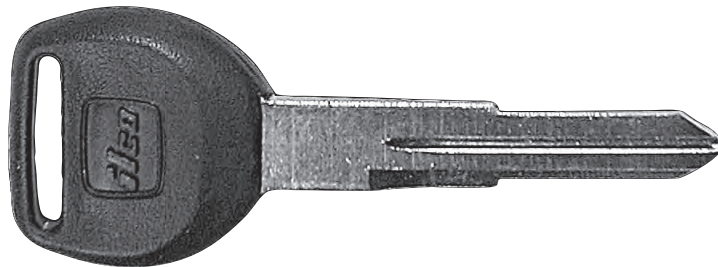

B65P
1791180547
 Non OEM

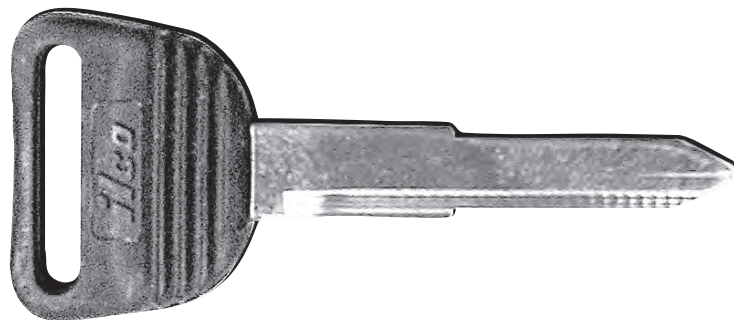

HD90P
1791181667
 Non OEM

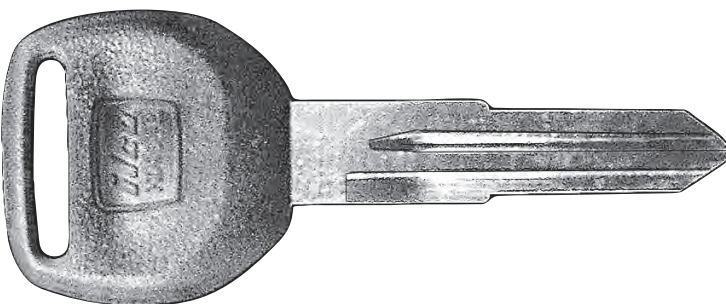

HD98
1791165896
 Non OEM

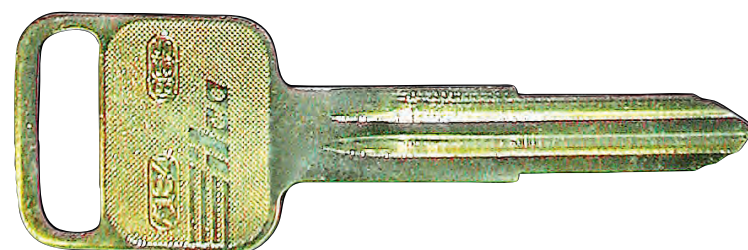

HD103
1791181605
 Non OEM

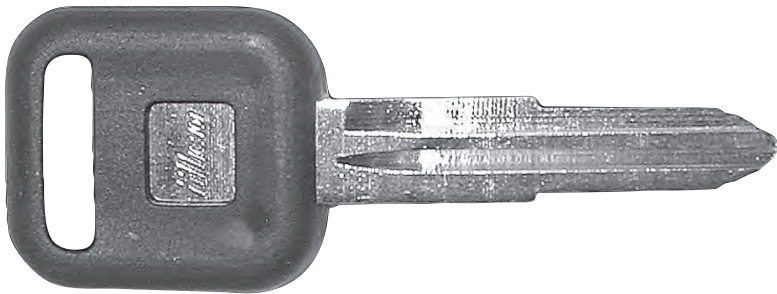
HONDA (CONTINUED)

HD103P
1791181636
 Non OEM

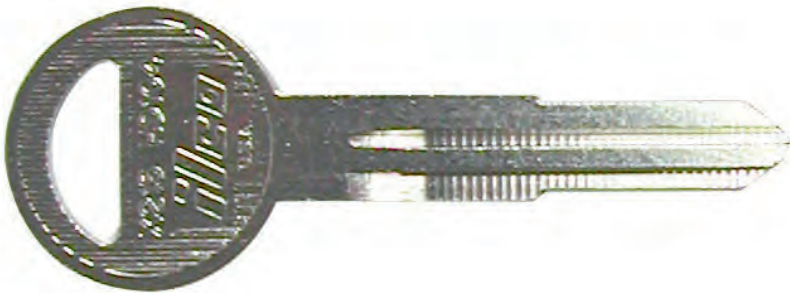

HD104
1791169993
 Non OEM

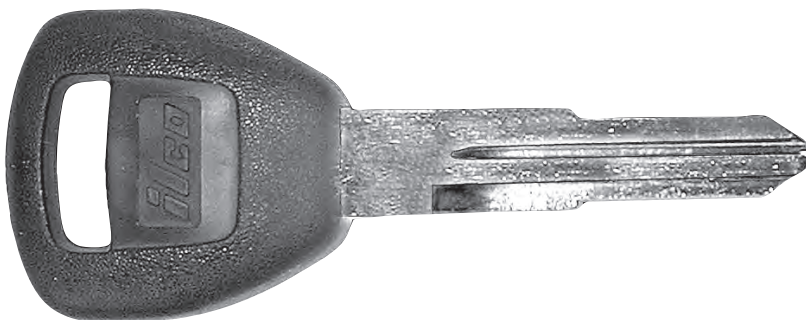

HD106PT5
1791 182169
Requires RW2
Transponder
 Non OEM

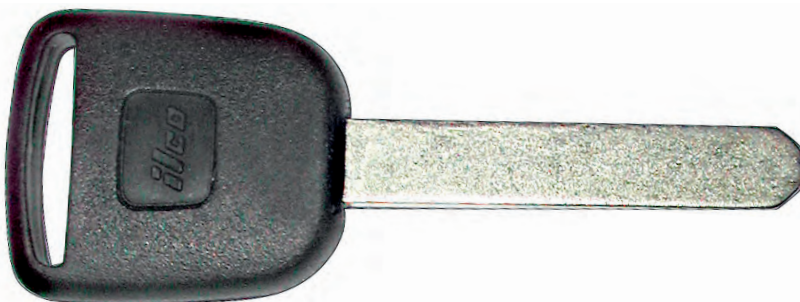

HO01T5
179199761
Requires RW2
Transponder
 Non OEM

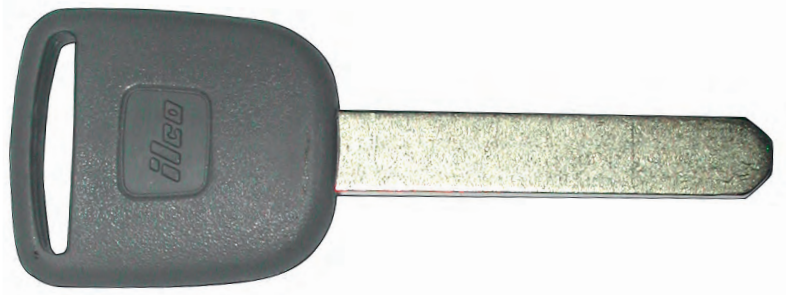

HONDA (CONTINUED)

HOV01T5
1791 99778
Requires RW2
Transponder
Non OEM

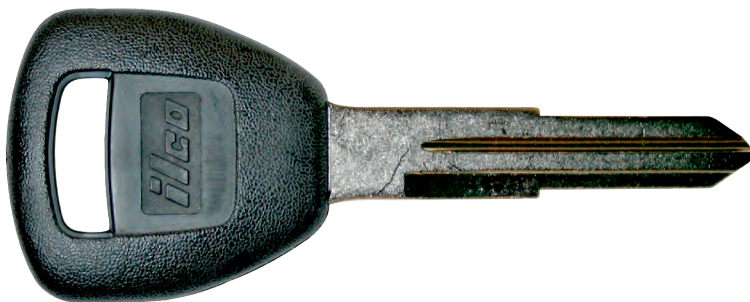

HD106PT
1791 206353
Requires RW2
Transponder
Non OEM

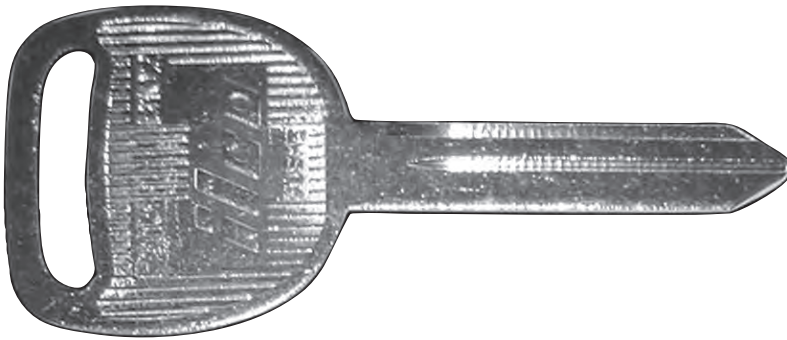

HUMMER

B102
1791195299
Non OEM

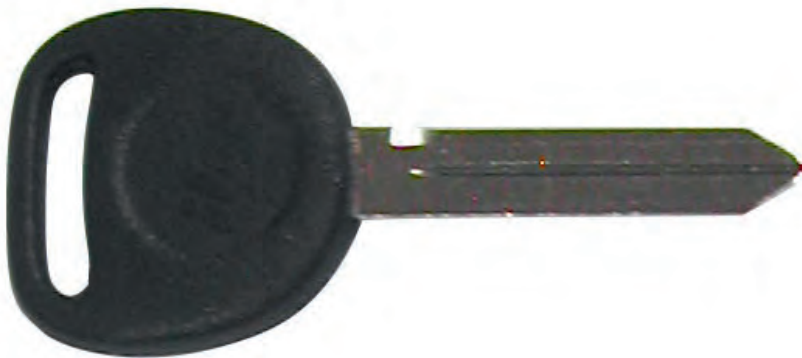

B102P
1791195275
Non OEM

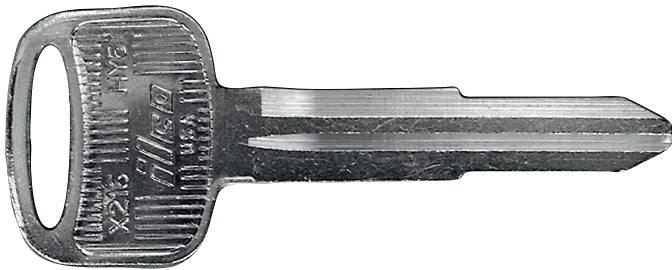

HYUNDAI

HY6
1791170517
Non OEM

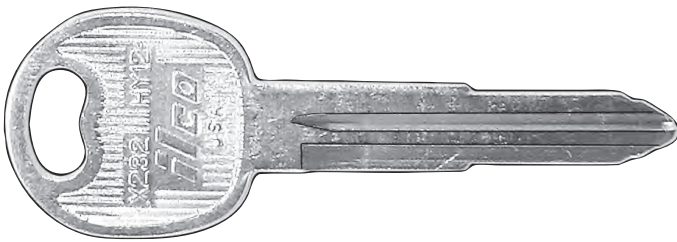

HY12
1791176175
Non OEM

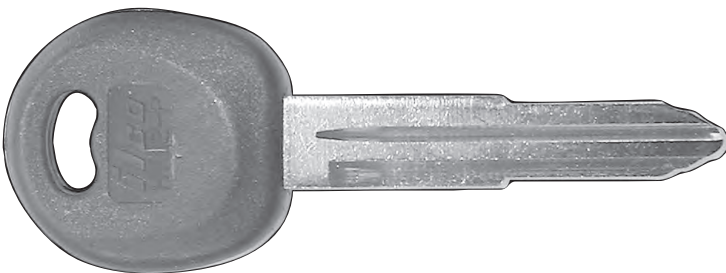

HY12P
1791176182
Non OEM

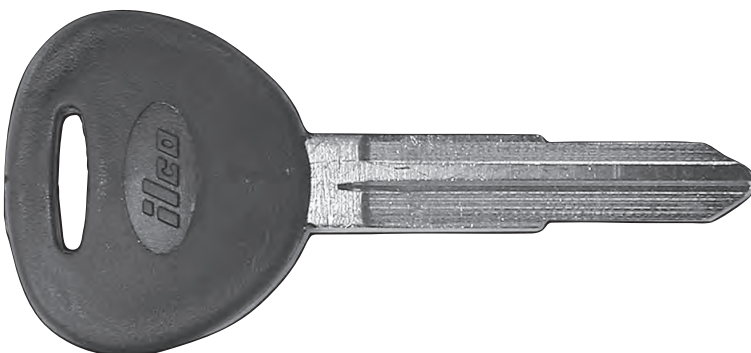

HY13P
1791179374
Non OEM

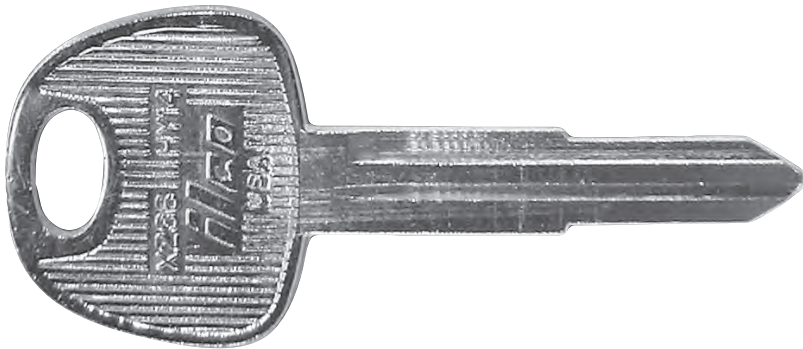

HYUNDAI (CONTINUED)

HY14
1791180011
Non OEM



HY14P
1791180028
Non OEM

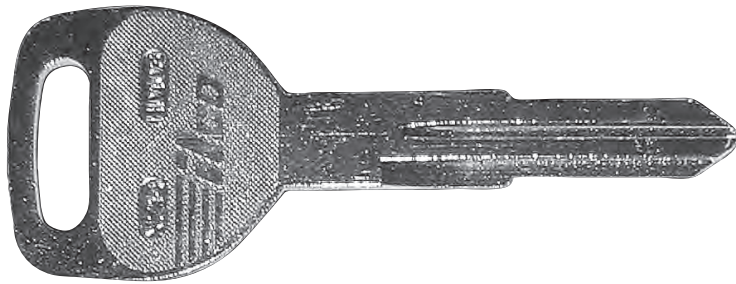

ISUZU

B65
1791181568
 Non OEM

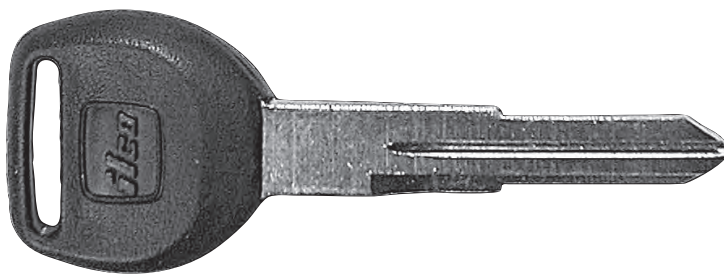

B65P
1791180547
 Non OEM

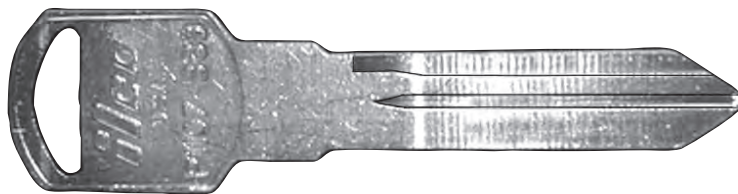

B89
1791179794
 Non OEM

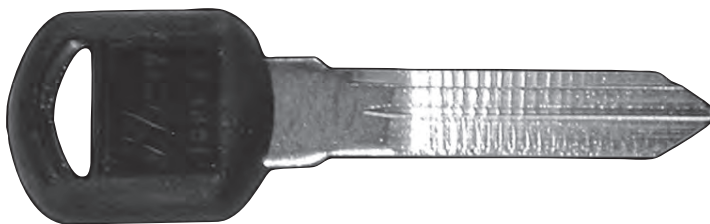

B89P
1791179824
 Non OEM

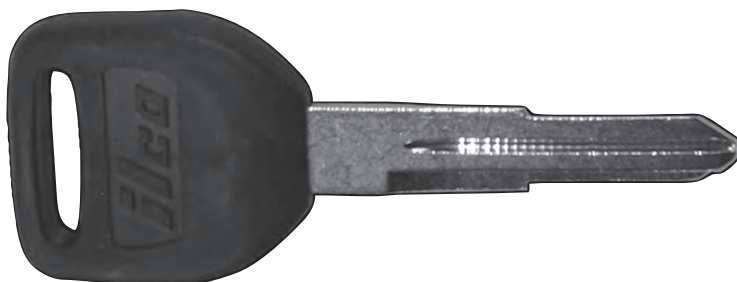

B101P
1791191703
 Non OEM

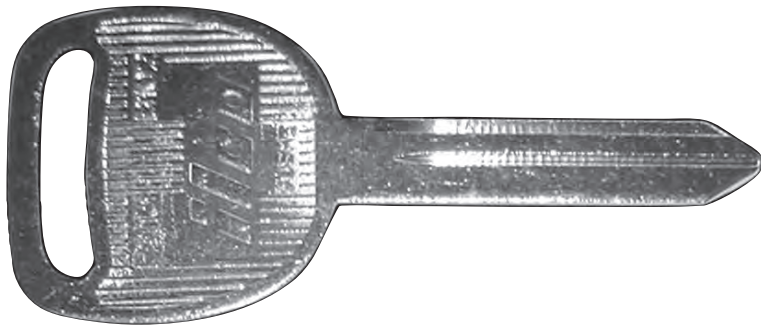
ISUZU (CONTINUED)

B102
1791195299
Non OEM

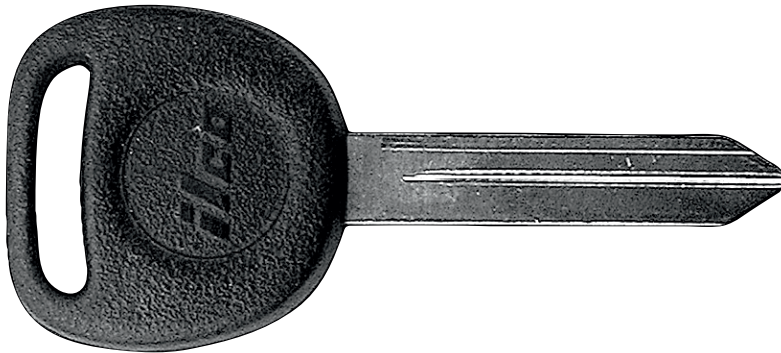

B102P
1791195275
Non OEM

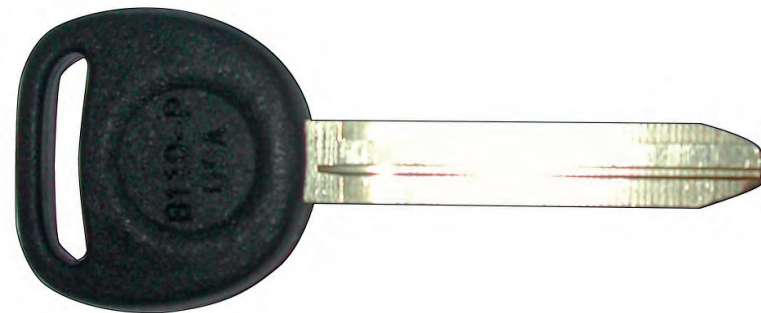

B110P
1791214044
Non OEM

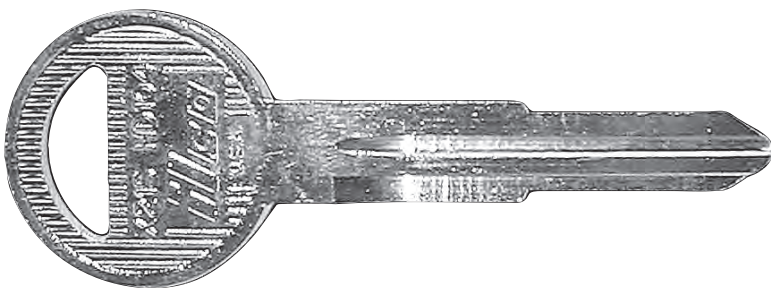

HD104
1791169993
Non OEM



JEEP

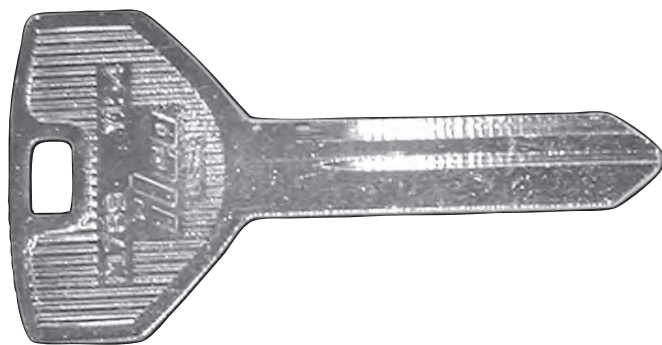

RA4
17913602
 OEM

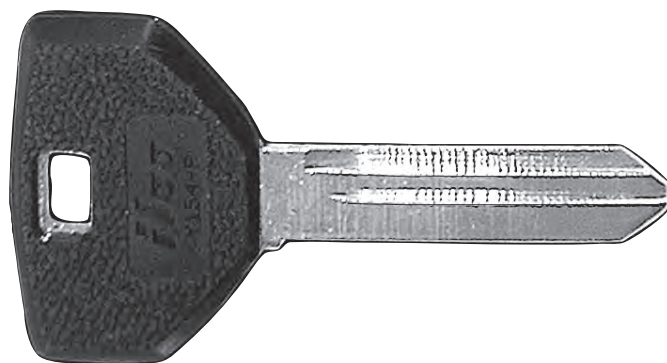

Y154
1791147632
 Non OEM

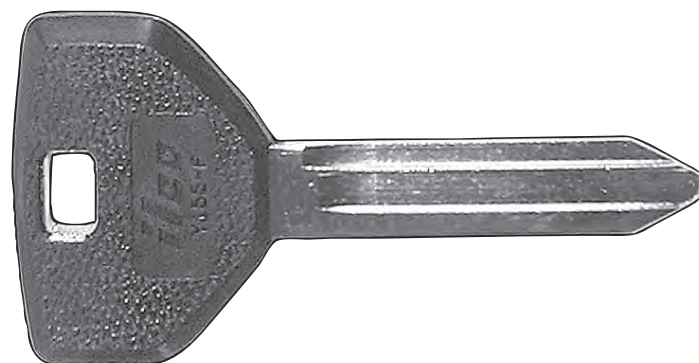

Y154P
1791134281
 Non OEM

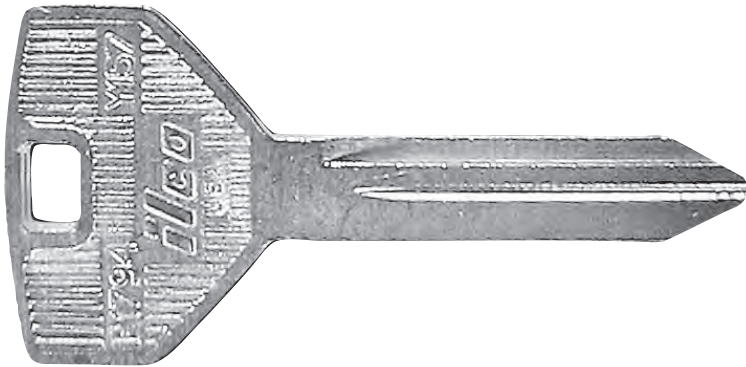

Y155P
1791173259
 Non OEM

JEEP (CONTINUED)

Y157
1791175710
Non OEM



Y157P
1791175727
Non OEM

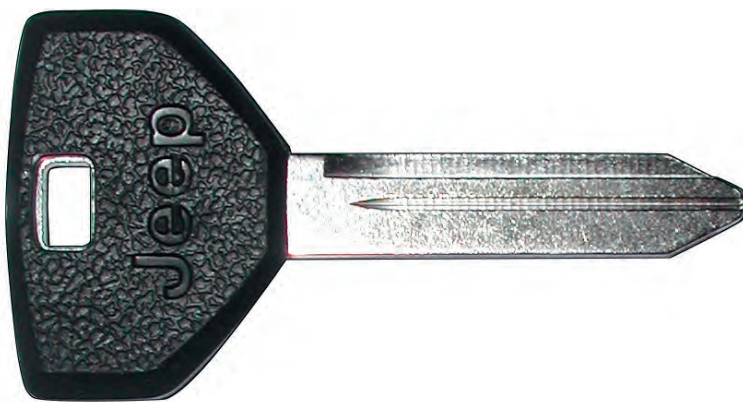

Y157PJP
17913503
OEM



Y159
1791179077
Non OEM



JEEP (CONTINUED)



Y159P
1791179084
 Non OEM

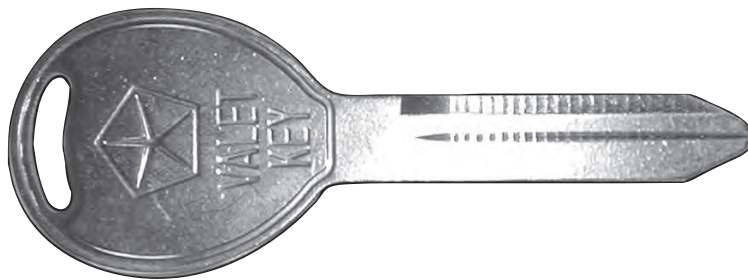

Y159JP
17913211
 OEM

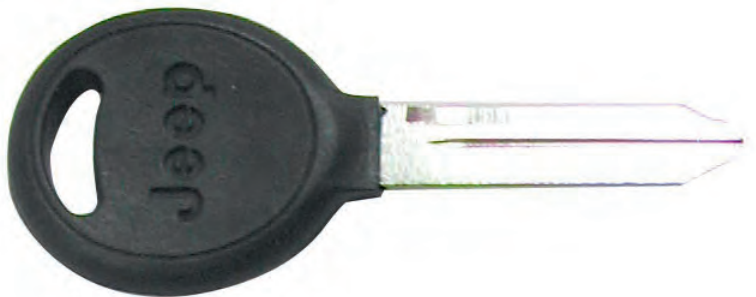

Y159PJP
17913215
 OEM

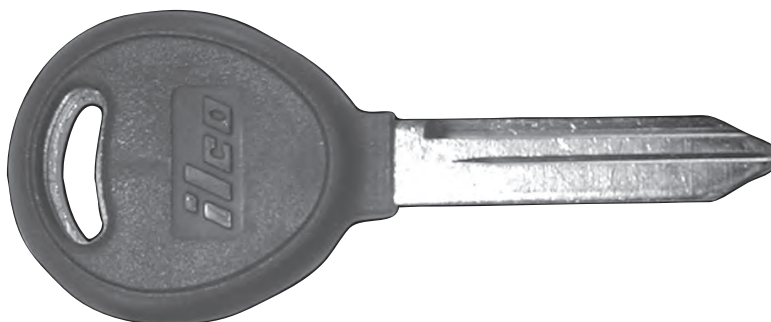

Y160PT
1791 187164
Transponder
Requires SDD
 Non OEM

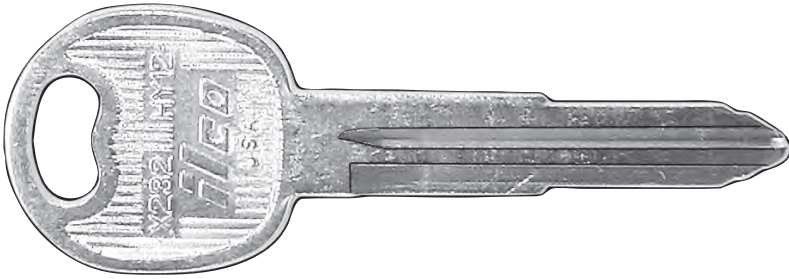

KIA

HY12
1791176175
Non OEM

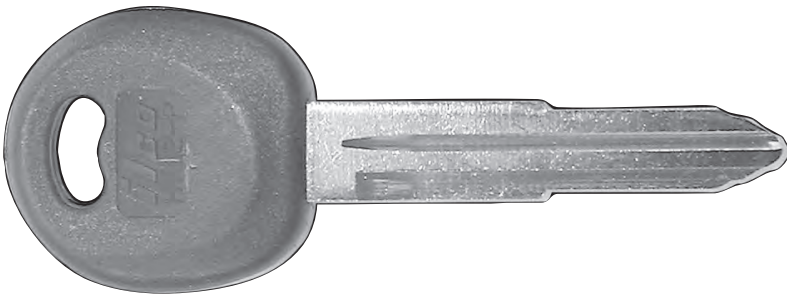

HY12P
1791176182
Non OEM

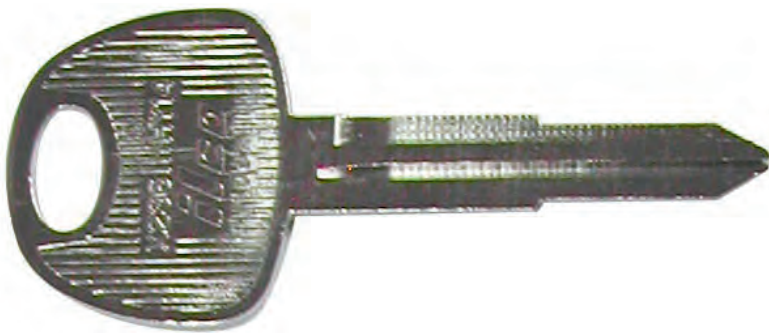

HY14
1791180011
Non OEM



HY14P
1791180028
Non OEM

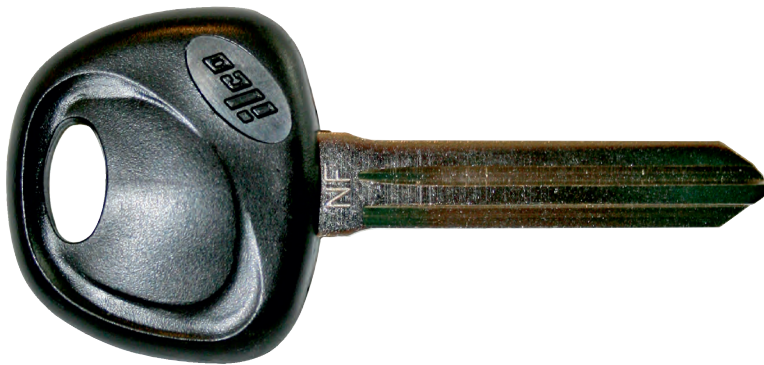

KIA (CONTINUED)

HY15
1791180030
 Non OEM

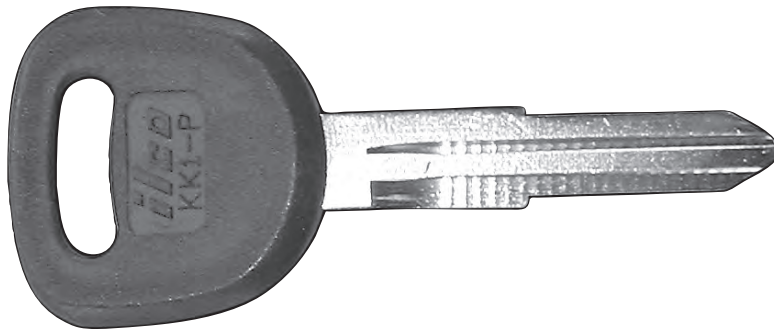

KK1P
1791178230
 Non OEM



KK2
1791180189
 Non OEM

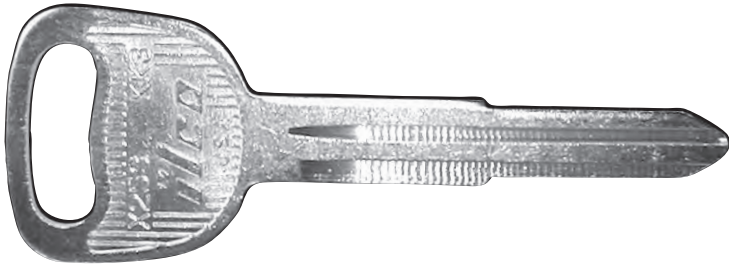

KK2P
1791180196
 Non OEM

KIA (CONTINUED)

KK3
1791193738
Non OEM

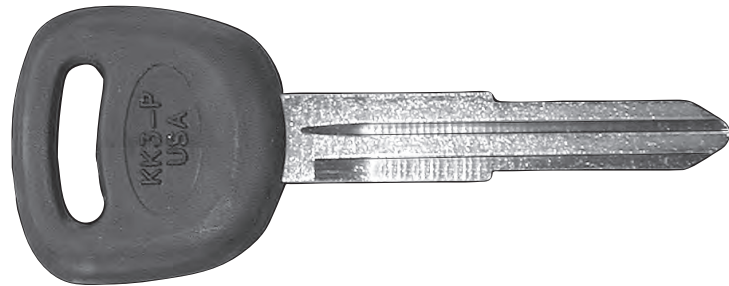

KK3P
1791193745
Non OEM

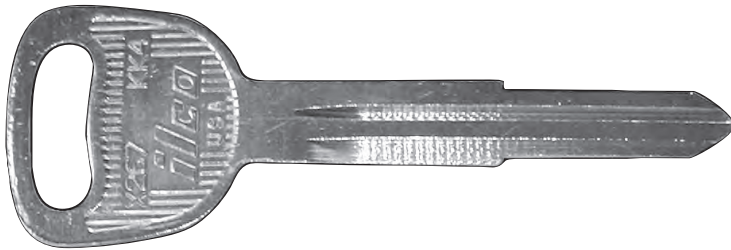

KK4
1791197644
Non OEM

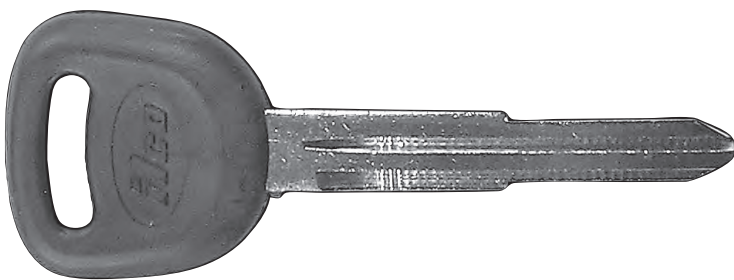

KK4P
1791197651
Non OEM

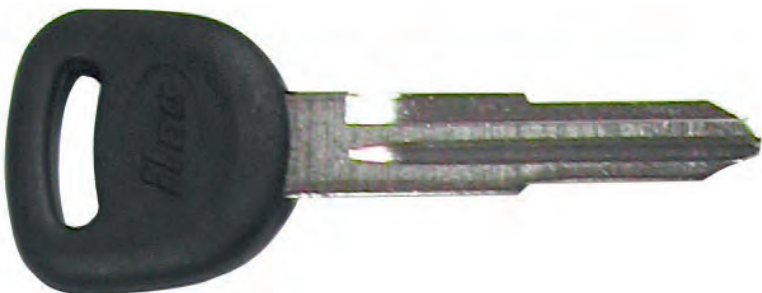

KK5
1791206766
Non OEM

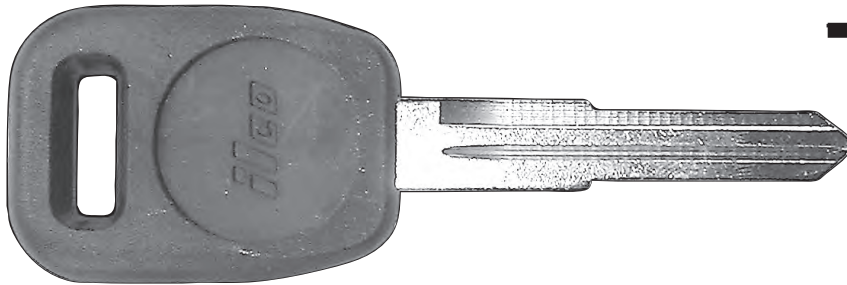

LAND ROVER

RV4P
1791180073
Non OEM



LEXUS

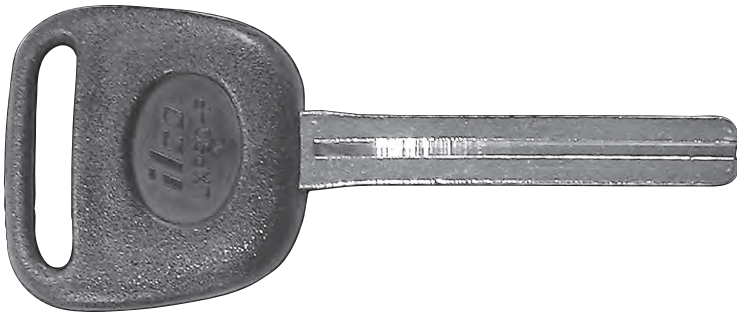

LXP90P
1791166749
High Security
Non OEM

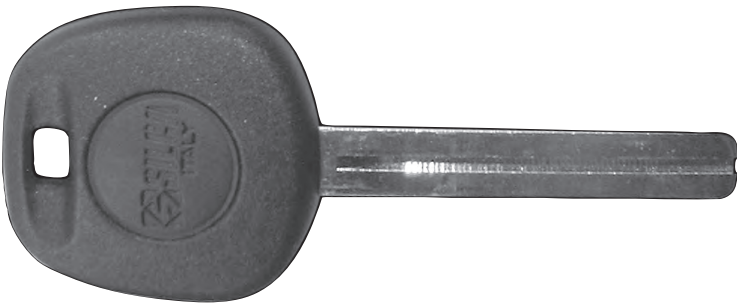

TOY40BT4
1791195206
Transponder
High Security
Non OEM
OBP

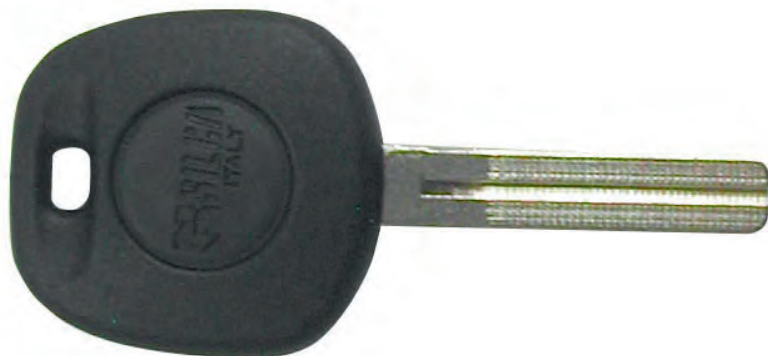

TOY48BT4
1791195411
Transponder
High Security
Non OEM
OBP



LINCOLN

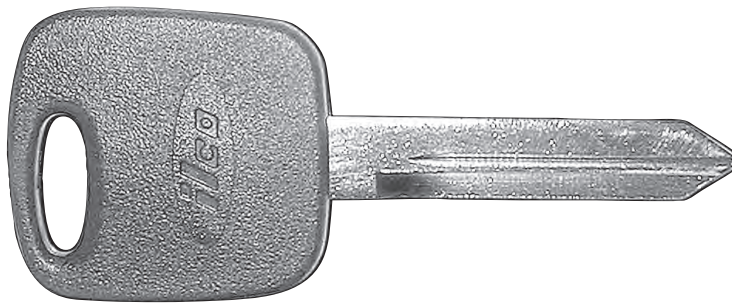

H72PT
1791179459
Transponder
Requires SDD
 Non OEM

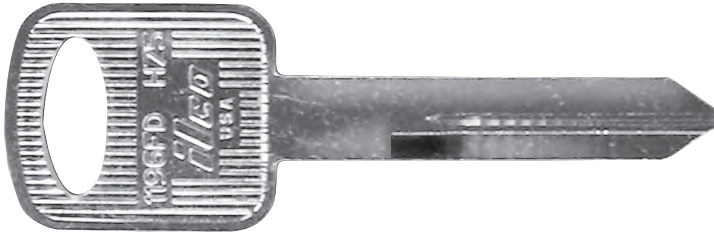

H74PT
17912605
Transponder
Requires SDD
or OBP
 Non OEM

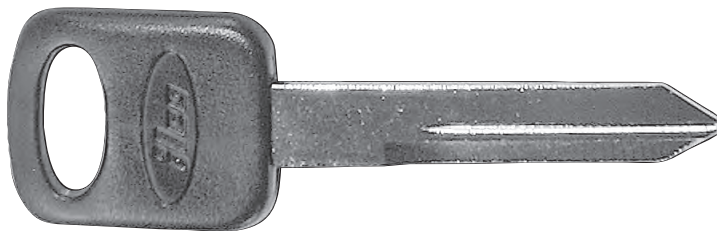

H75
1791180080
 Non OEM



H75P
1791180097
 Non OEM



MAZDA

H72PT
1791179459
Transponder
Non OEM

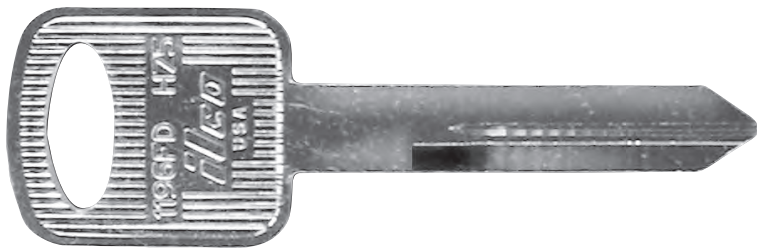

H75
1791180080
Non OEM

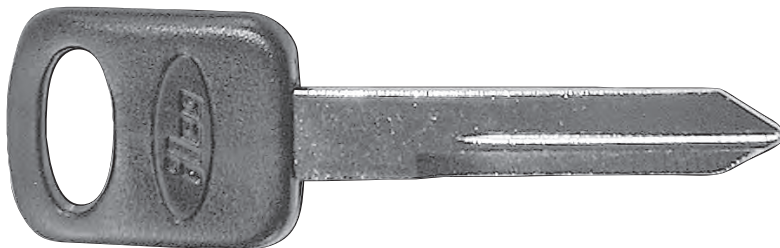

H75P
1791180097
Non OEM



H86 PT
17912609
Transponder
Requires SDD
or OBP
Non OEM



MAZDA (CONTINUED)



LXP90P
1791 166749
High Security
 Non OEM



MZ27
1791173914
 Non OEM

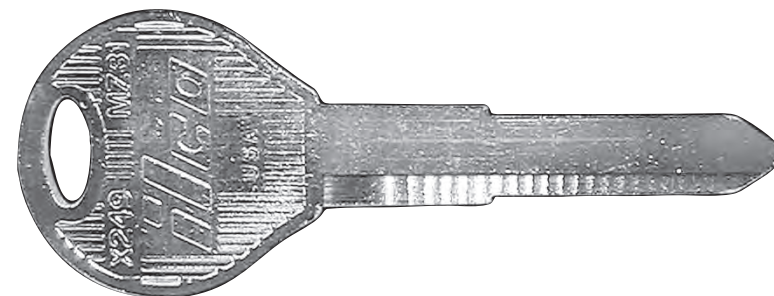

MZ27P
1791173921
 Non OEM



MZ31
1791182619
 Non OEM

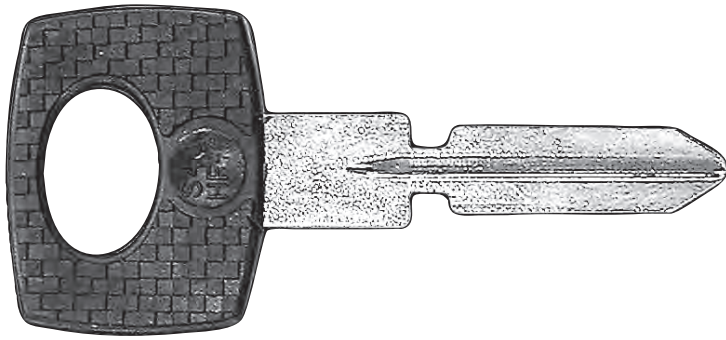

MERCEDES-BENZ

S48HFP

1791134076**High Security**

Non OEM



MERCURY



H72PT
1791179459
Requires SDD
or OBP
 Non OEM

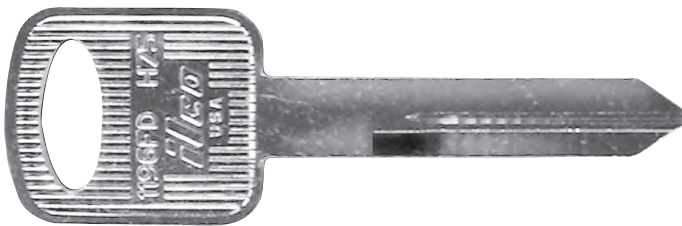

H73PT
1791180004
Transponder
Requires SDD
or OBP
 Non OEM

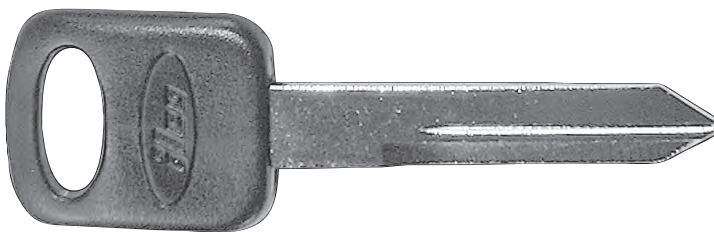

H75
1791180080
 Non OEM



H75P
1791180097
 Non OEM



H76
1791181094
 Non OEM

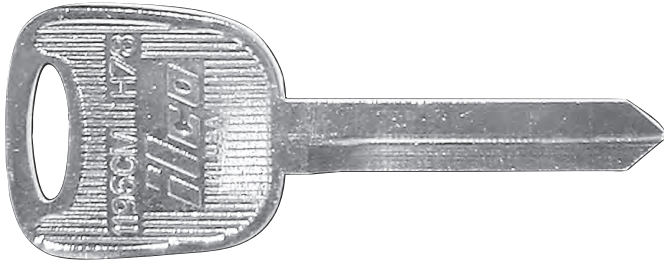

MERCURY (CONTINUED)

H78

1791181049

Non OEM

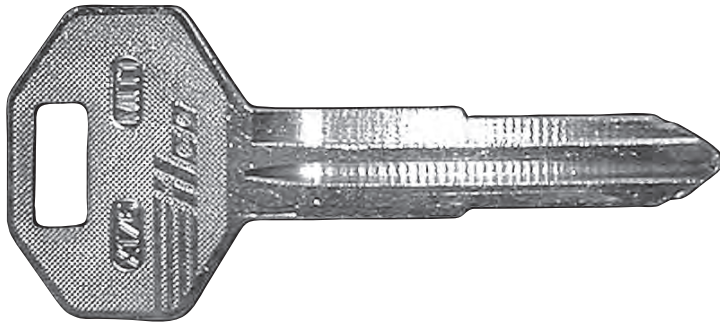

MITSUBISHI

MIT1
1791181476
Non OEM

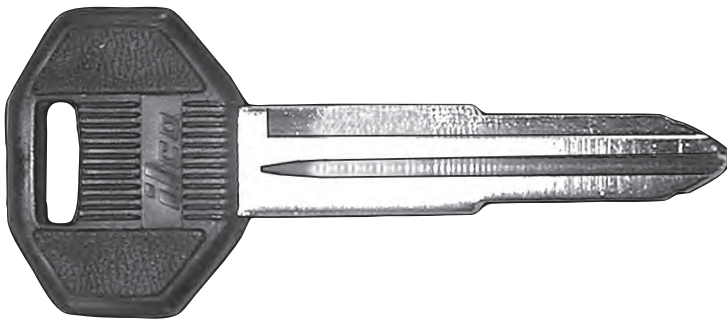

MIT1P
1791181629
Non OEM

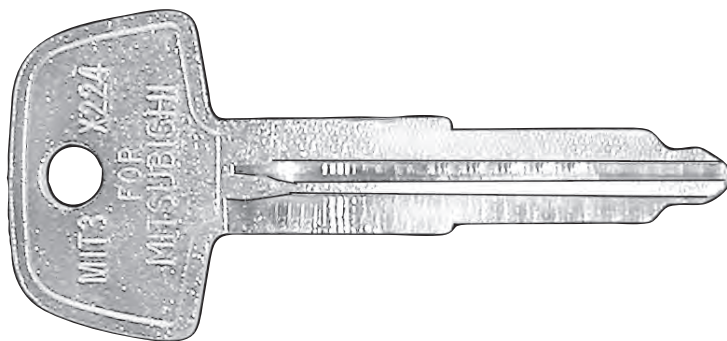

MIT3
1791173945
Non OEM

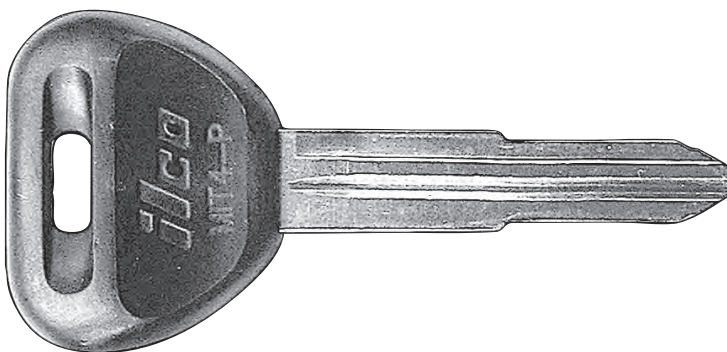

MIT4P
179118093
Non OEM

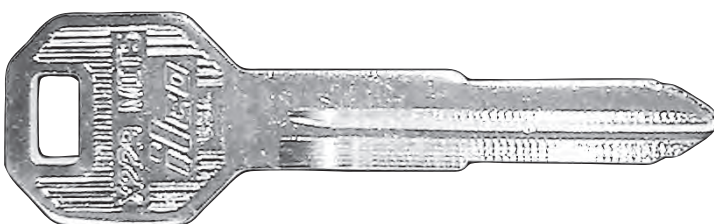

MIT5
1791174638
Non OEM

MITSUBISHI (CONTINUED)

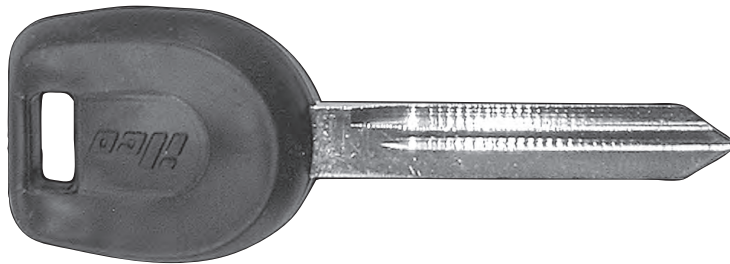

MIT6
1791195022
 Non OEM

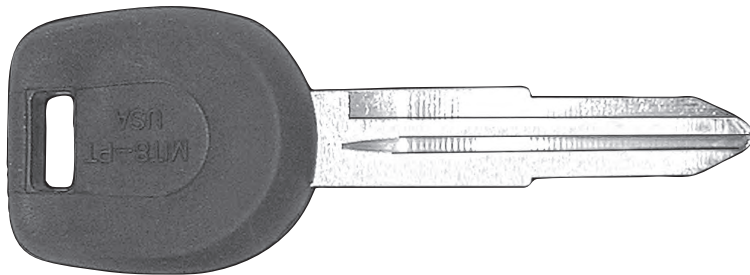

MIT6P
1791195046
 Non OEM

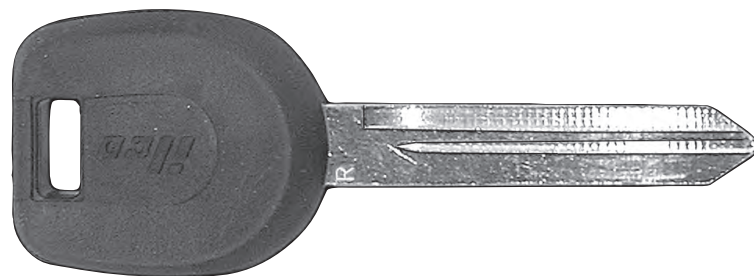

MIT8PT
1791196647
Transponder
Requires SDD
 Non OEM



MIT9PT
1791196454
Transponder
Requires SDD
 Non OEM



NISSAN



DA25
1791181513
 Non OEM

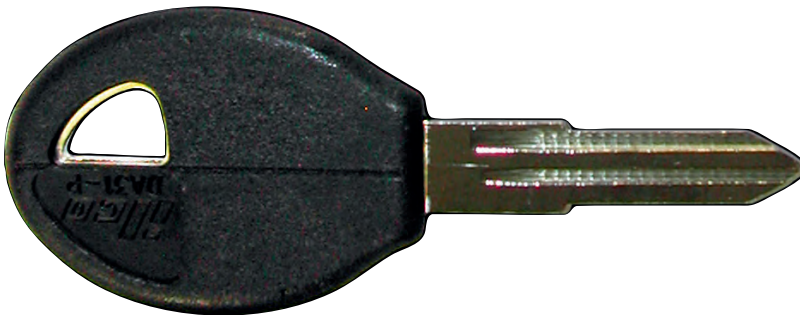

DA31
1791181520
 Non OEM

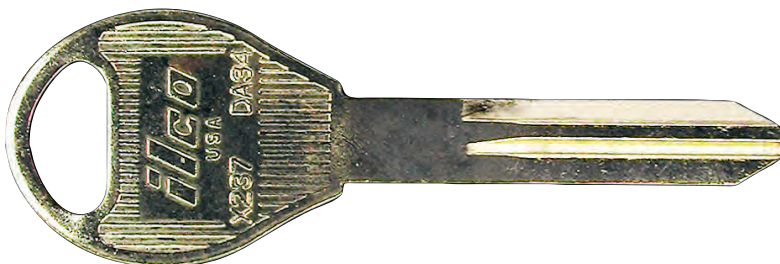

DA31P
1791181681
 Non OEM



DA34
1791180035
 Non OEM

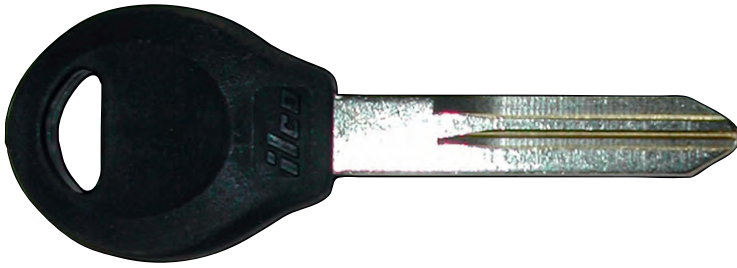

NISSAN (CONTINUED)

DA34P
1791180042
 Non OEM

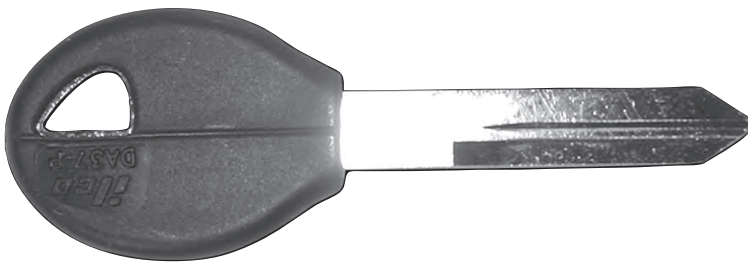

DA37P
1791180455
 Non OEM

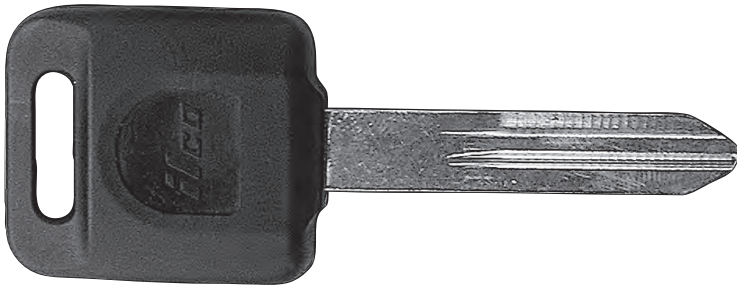

N101T
1791199792
Transponder
Requires SDD
 Non OEM



N102T
1791199785
Transponder
Requires SDD
 Non OEM



OLDSMOBILE



B44P
17913025
 Non OEM

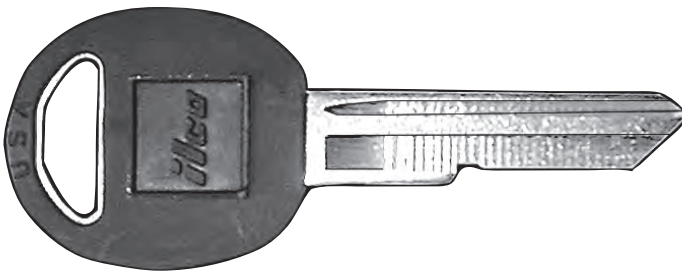

B45
1791100095
 Non OEM

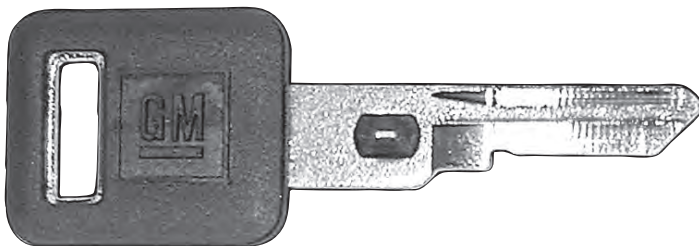

B45P
1791167364
 Non OEM



B62
 OEM Pass Vats
 Single Sided

Key #	OEM Art #	Key #	OEM Art #
1	17912001	9	17912009
2	17912002	10	17912010
3	17912003	11	17912011
4	17912004	12	17912012
5	17912005	13	17912013
6	17912006	14	17912014
7	17912007	15	17912015
8	17912008		

OLDSMOBILE (CONTINUED)



B79
1791167807
 Non OEM

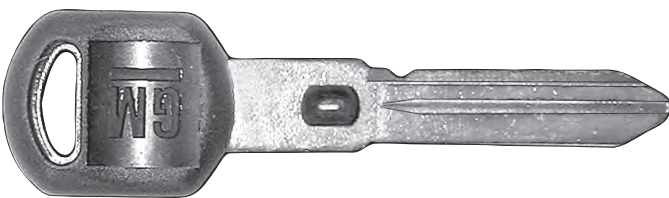

B82
 OEM Pass Vats
 Double Sided

Can be substituted for Corvette Vats

Key #	OEM Art #	Key #	OEM Art #
2	17912016	9	17912023
3	17912017	10	17912024
4	17912018	11	17912025
5	17912019	12	17912026
6	17912020	13	17912027
7	17912021	14	17912028
8	17912022	15	17912029

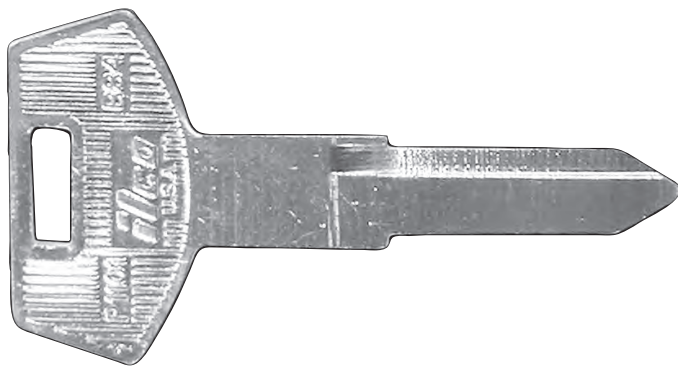

B84
1791174256
 Non OEM

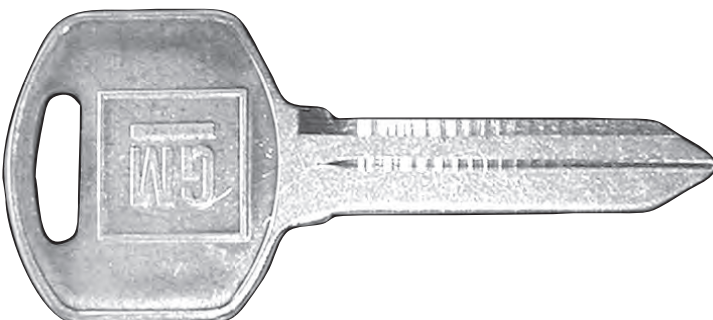

B85
17913042
 Non OEM



OLDSMOBILE (CONTINUED)

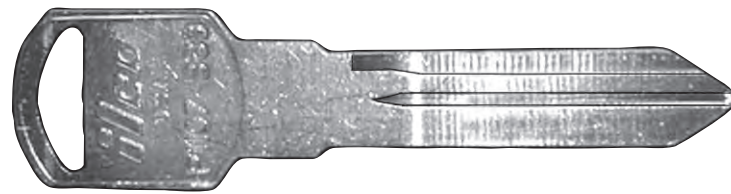

B86
1791179398
 Non OEM

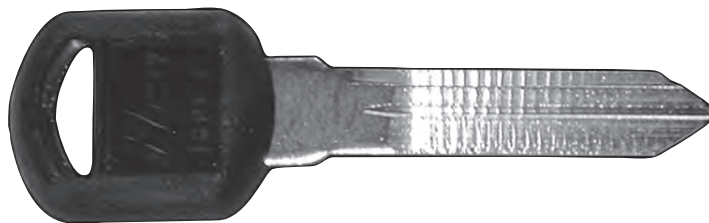

B89
1791179794
 Non OEM

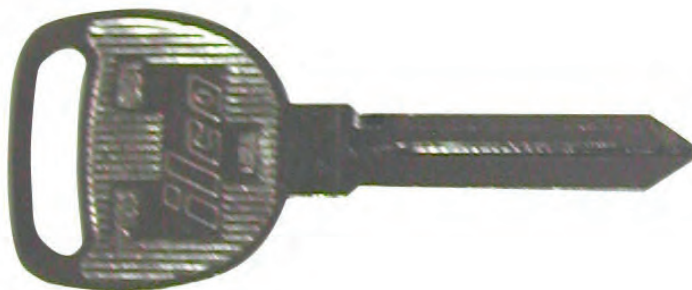

B89P
1791179824
 Non OEM



B91
1791182145
 Non OEM

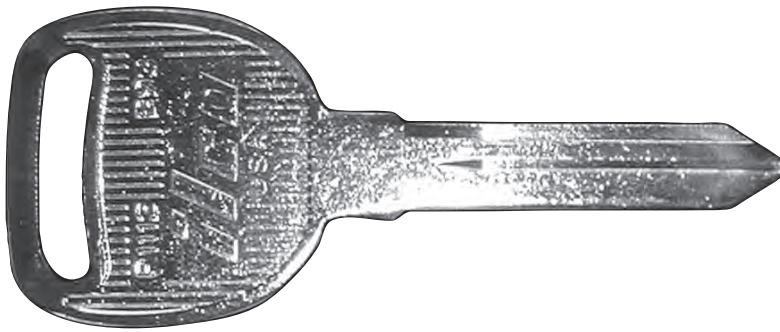

B91P
1791182152
 Non OEM

OLDSMOBILE (CONTINUED)

B93
1791192854
 Non OEM



B93P
1791192861
 Non OEM

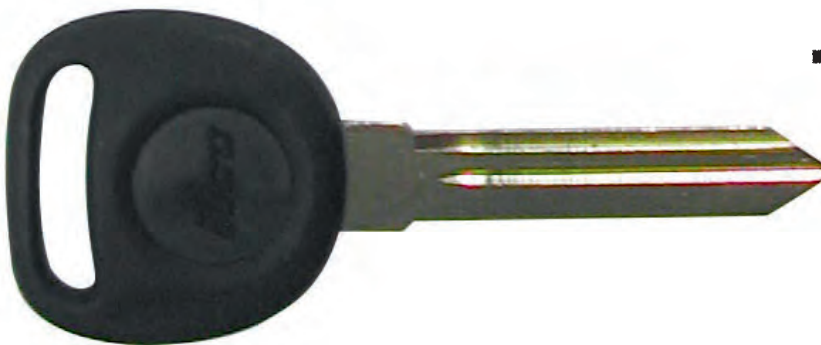

B99PT
1791191710
OBP Program
Transponder
 Non OEM

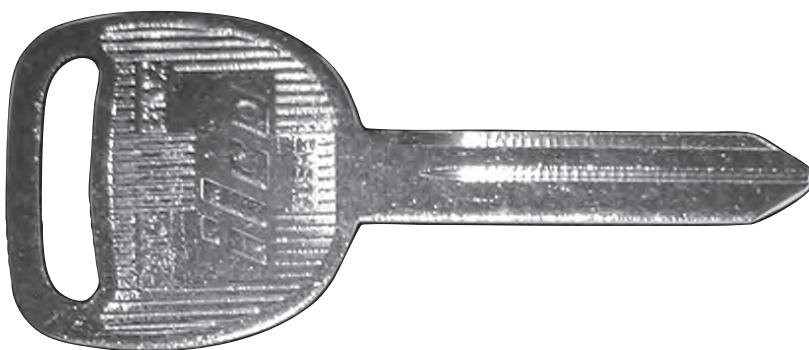

B102
1791195299
 Non OEM

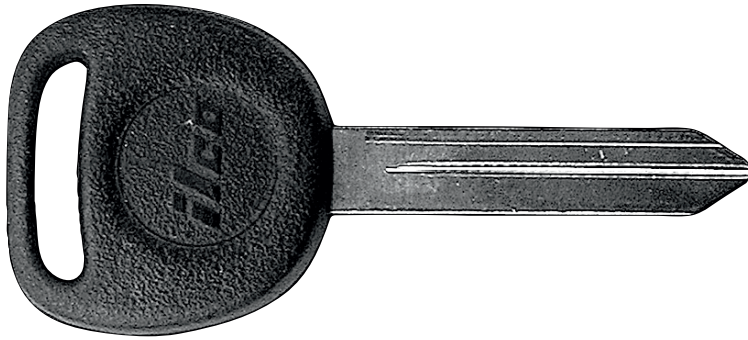

OLDSMOBILE (CONTINUED)

B102P
1791195275
Non OEM

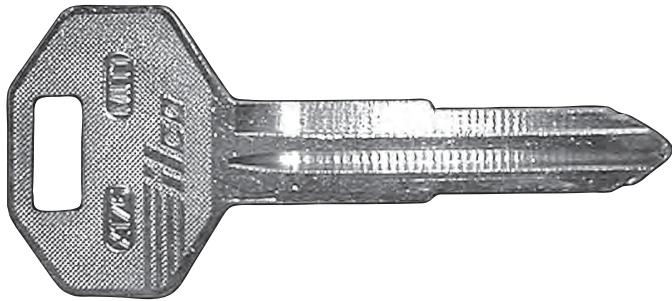

PLYMOUTH

MIT1
1791181476
Non OEM

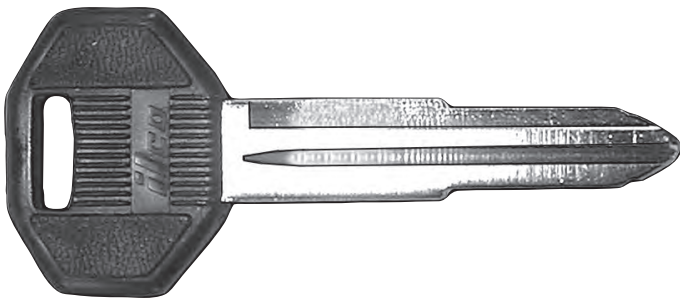

MIT1P
1791181629
Non OEM

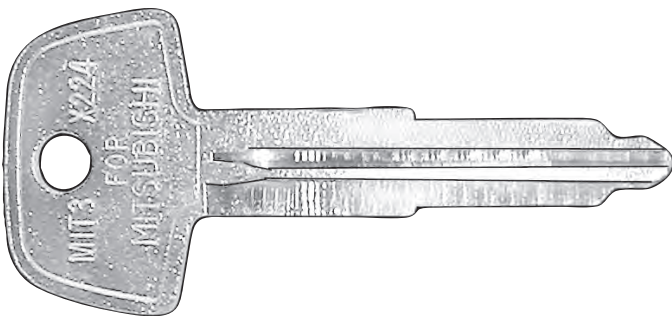

MIT3
1791173945
Non OEM

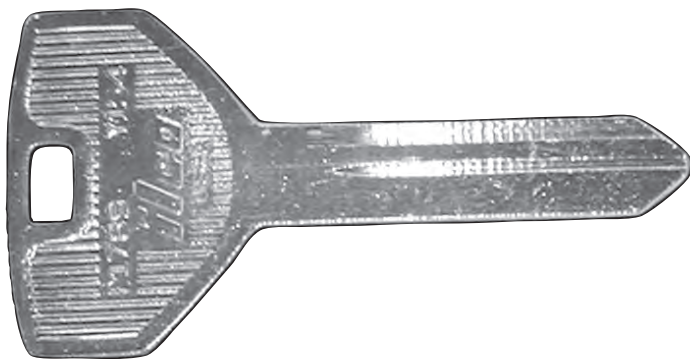

Y154
1791147632
Non OEM

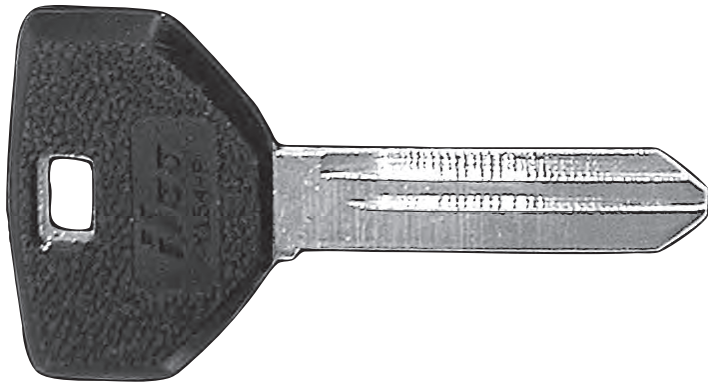

PLYMOUTH (CONTINUED)

Y154P
1791134281
Non OEM

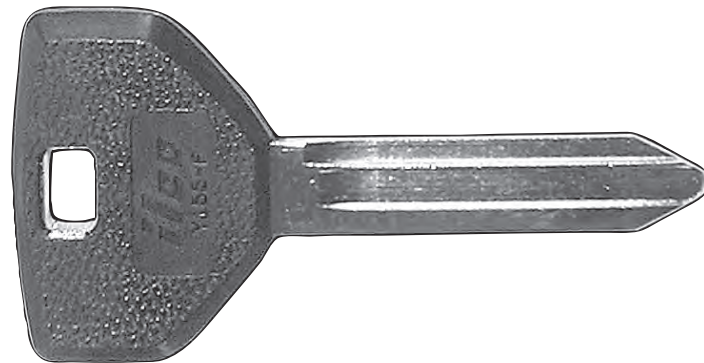

Y155P
1791173259
Non OEM

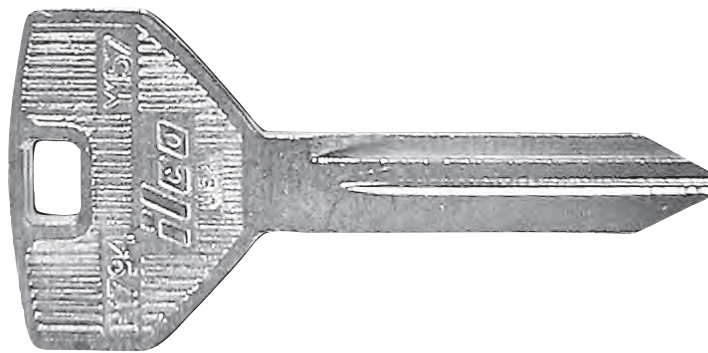

Y157
1791175710
Non OEM



Y157P
1791175727
Non OEM



PLYMOUTH (CONTINUED)

Y159
1791179077
Non OEM



Y159P
1791179084
Non OEM

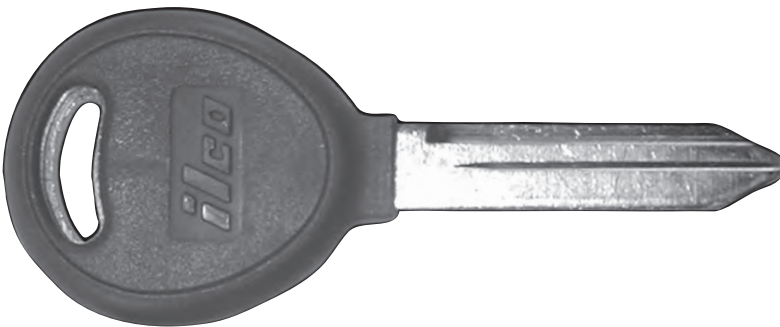

Y160PT
1791187164
Transponder
Requires SDD
or OBP
Non OEM



PONTIAC

B44P
17913025
Non OEM

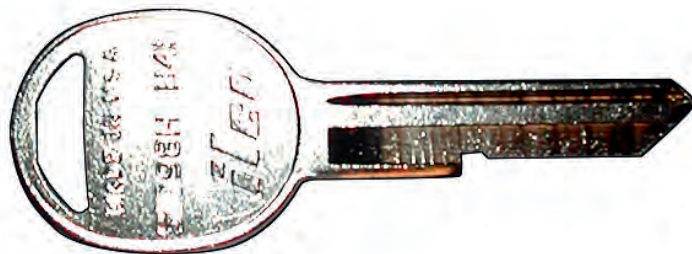

B45
1791100095
Non OEM

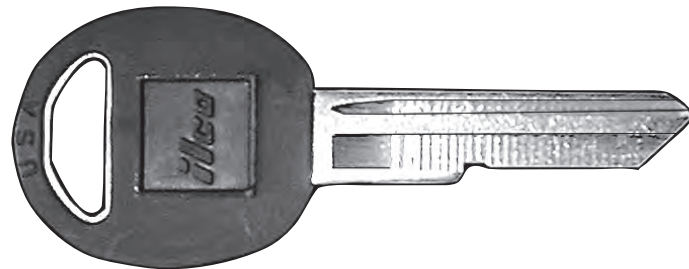

B45P
1791167364
Non OEM



B79
1791167807
Non OEM



B84
1791174256
Non OEM

PONTIAC (CONTINUED)

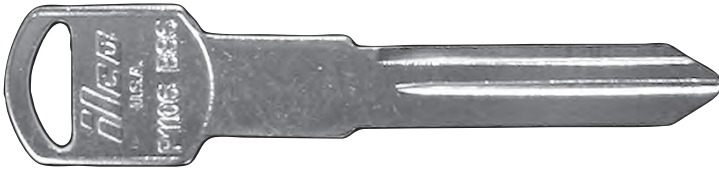

B86
1791179398
 Non OEM



B89
1791179794
 Non OEM

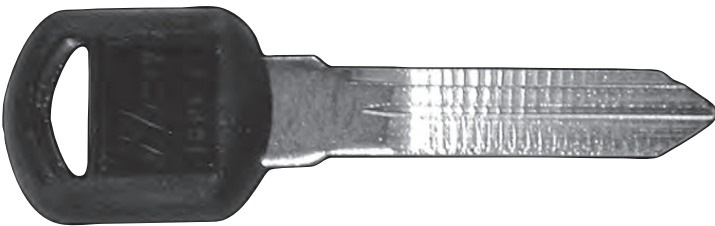

B89P
1791179824
 Non OEM

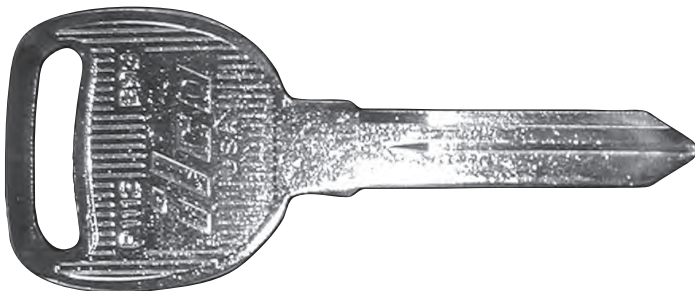

B93
1791192854
 Non OEM

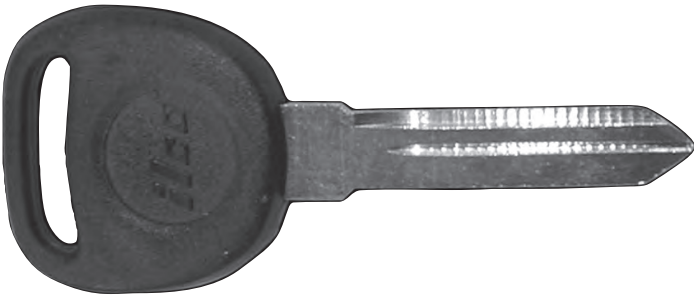

B93P
1791192861
Requires RW2
 Non OEM

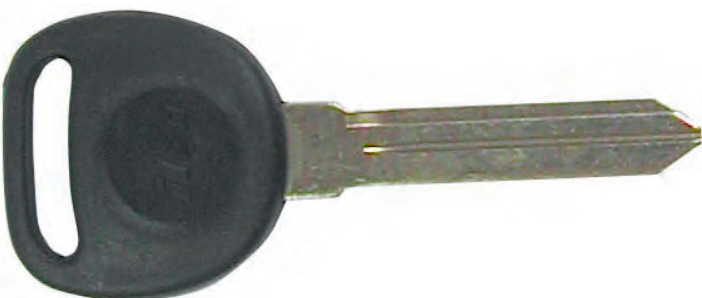

B99PT5
1791195251
Requires RW2
Transponder
 Non OEM



PONTIAC (CONTINUED)

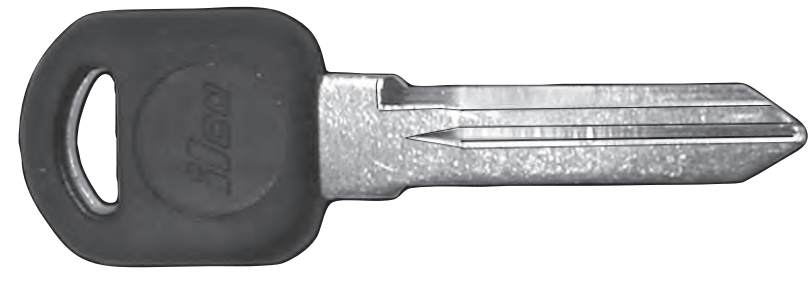

B103PT
1791196326
Transponder
 Non OEM

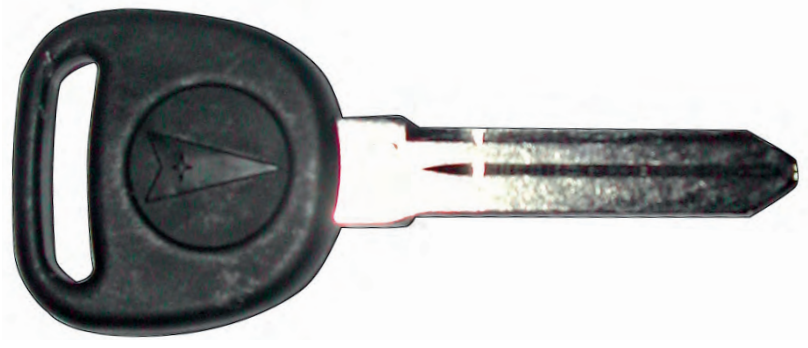

GMX-310
17910310
Requires RW2
or OBP
Transponder
 OEM

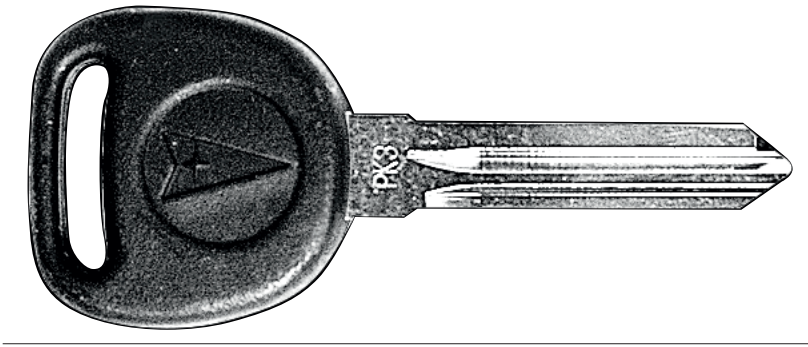

GMX-367
17913367
Requires RW2
or OBP
Transponder
 OEM

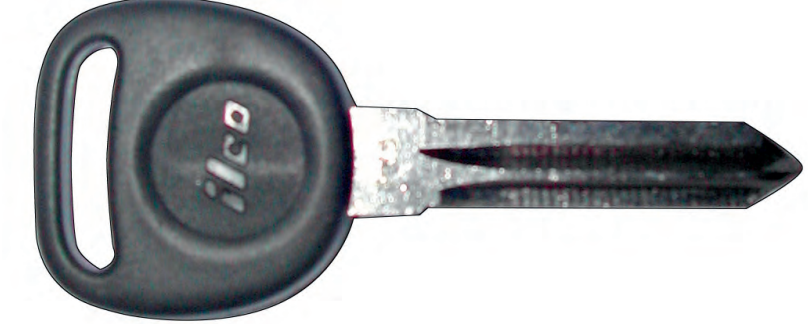

PTO4PT
1791206544
Requires RW2
or OBP
Transponder
 Non OEM



GMX381
17910381
Transponder
Requires RW2
or OBP
 OEM

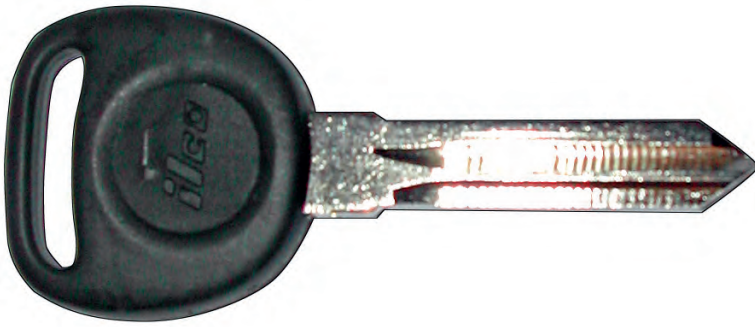

© 2011 WÜRTH USA, Inc. Revision 03/2011

PONTIAC (CONTINUED)

PT04PT5
1791206551
Transponder
Requires RW2
Non OEM

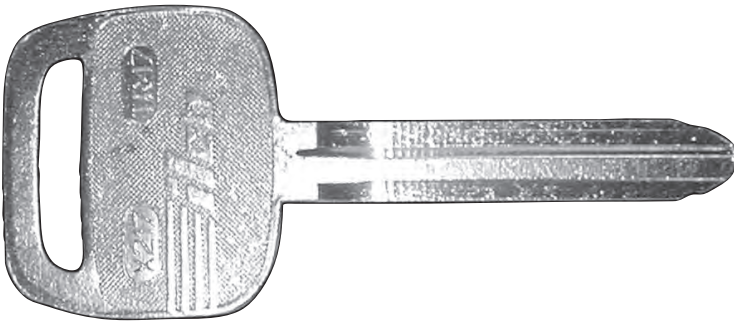

TR47
1791181551
Non OEM

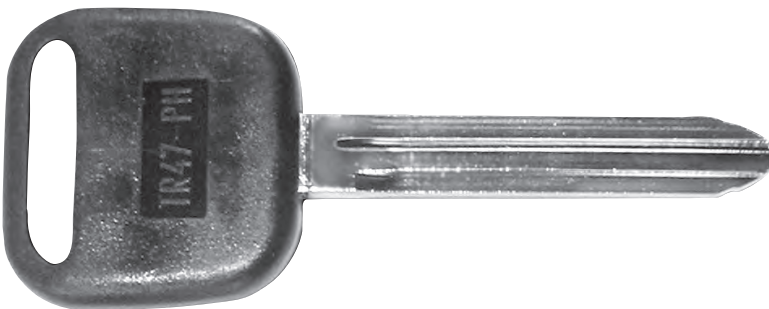

TR47P
1791181643
Non OEM

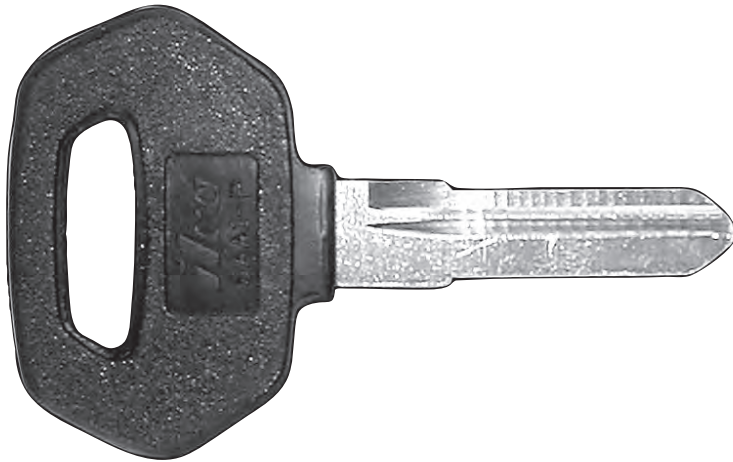

SAAB

SAA1P
1791134007
Non OEM

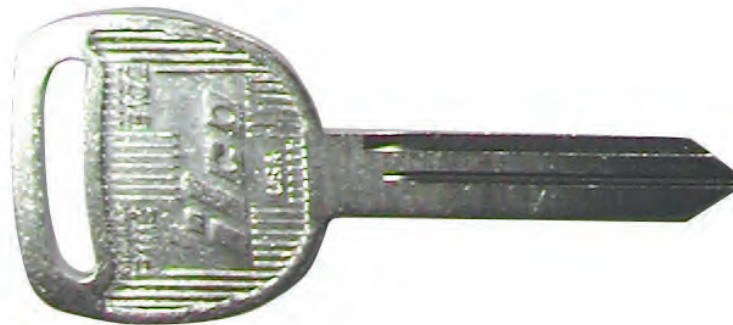

B102
1791195299
Non OEM

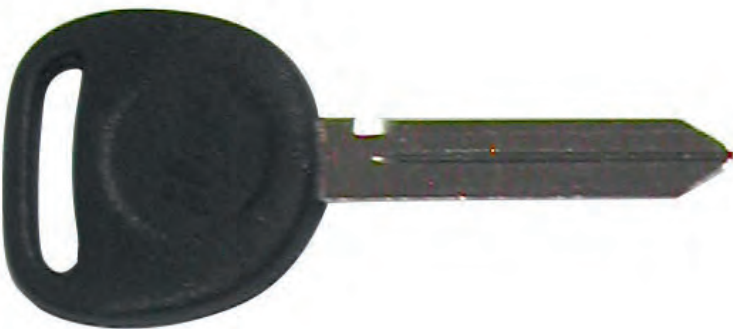

B102P
1791195275
Non OEM

SATURN



B88
1791179800
 Non OEM

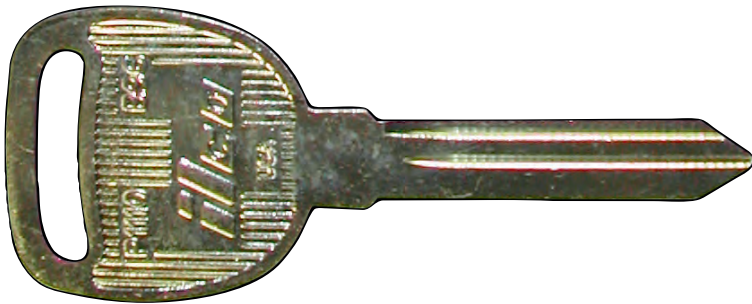

B88P
1791179534
 Non OEM

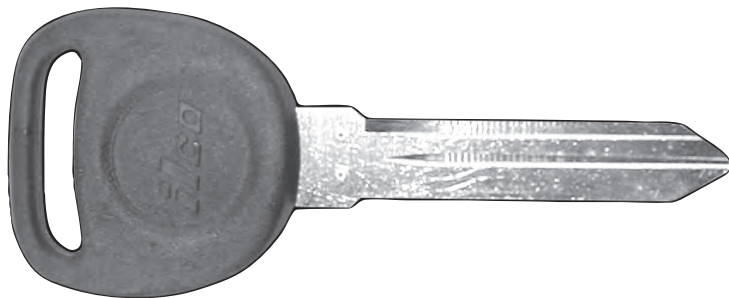

B96
1791192427
 Non OEM



B96P
1791192410
 Non OEM

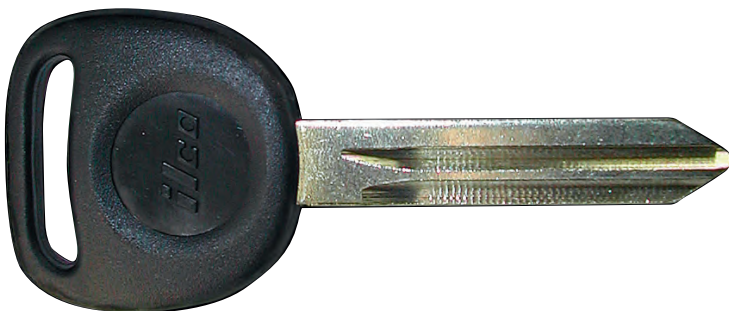

B106P
1791202348
 Non OEM

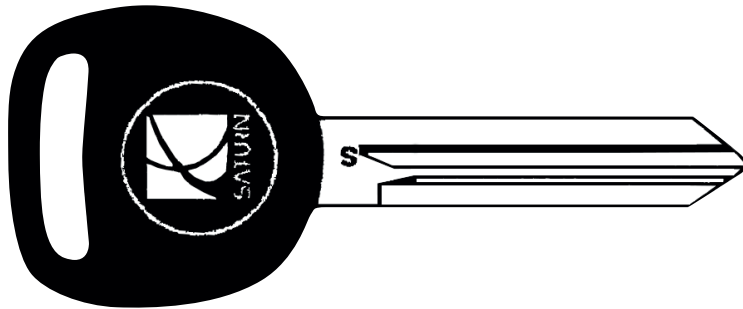

SATURN (CONTINUED)

B106P
17913052
OEM

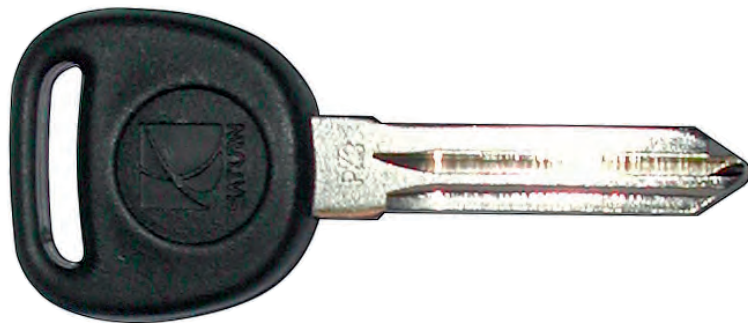

GMT-201S
17913055
Transponder
OEM



SUBARU

DA25
1791181513
Non OEM

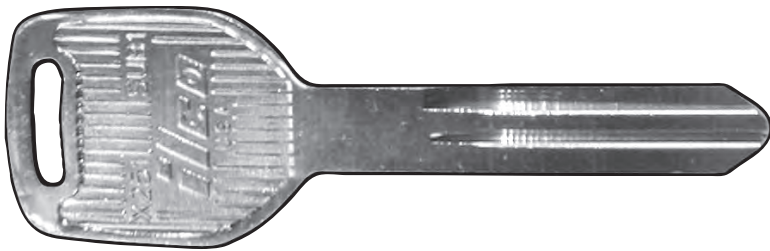

SUB1
1791192977
Non OEM

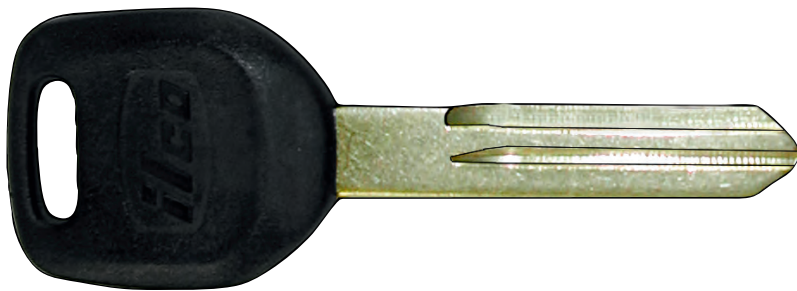

SUB1P
1791192984
Non OEM

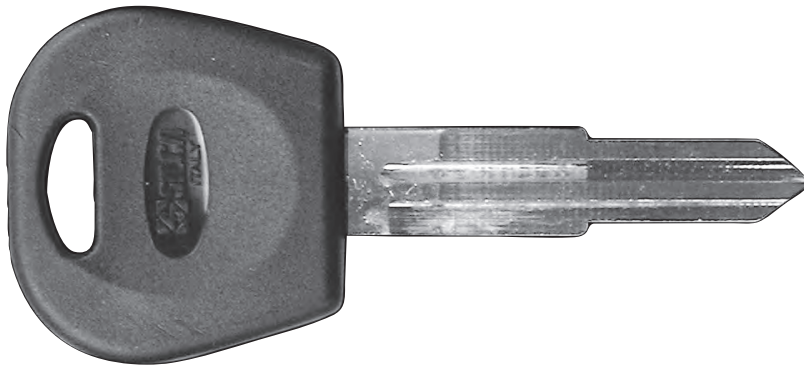

SUZUKI

DW04RAP
1791196418
Non OEM

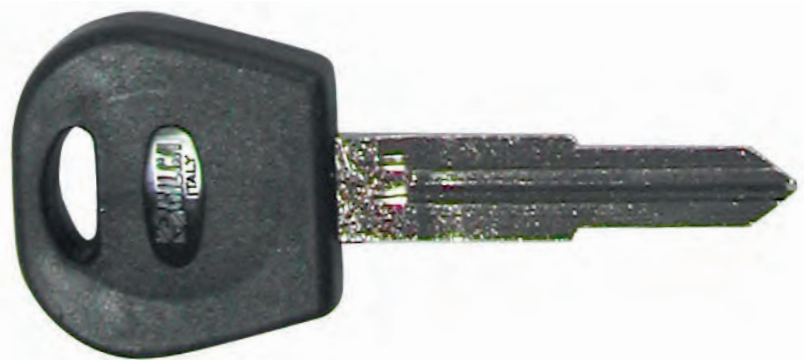

DW05AP
1791196395
Non OEM



SUZ15P
1791165186
Non OEM

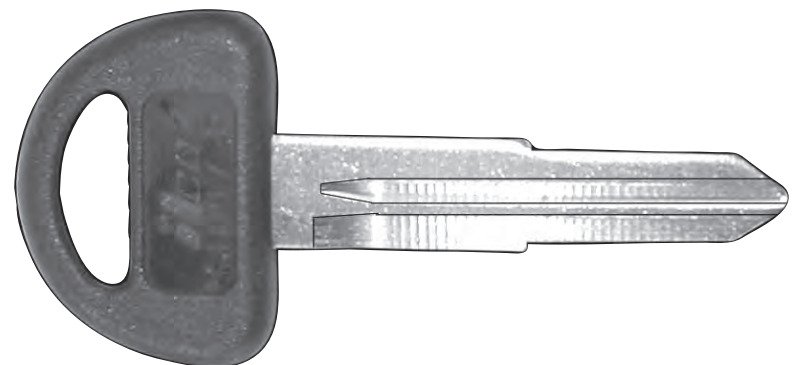

SUZ17P
1791165070
Non OEM

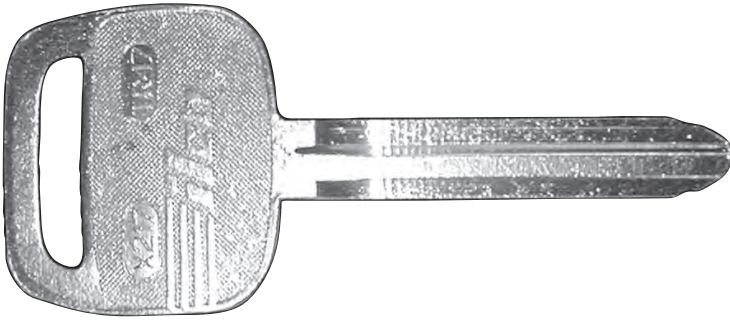
SUZUKI (CONTINUED)

TR47
1791181551
Non OEM

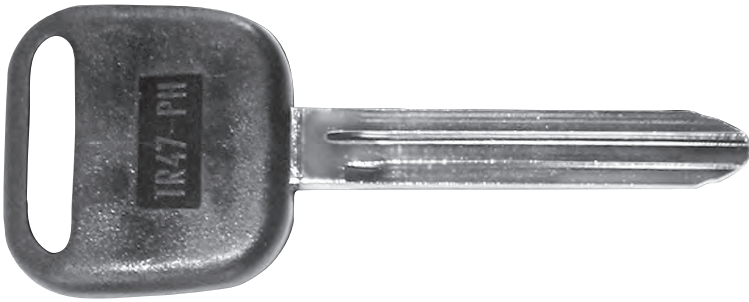

TR47P
1791181643
Non OEM

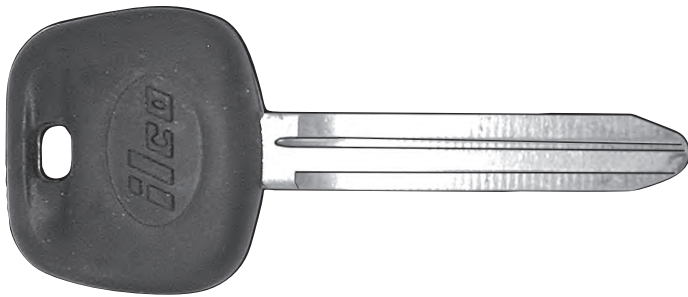

TOYOTA

TOY43AT4
1791193226
Transponder
or OBP
 Non OEM

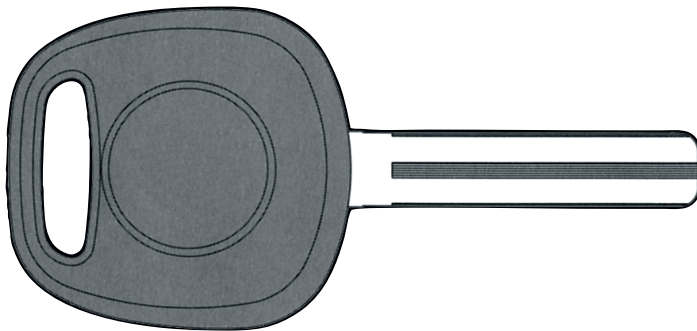

TOY48BT4
1791195411
Transponder
High Security
 Non OEM

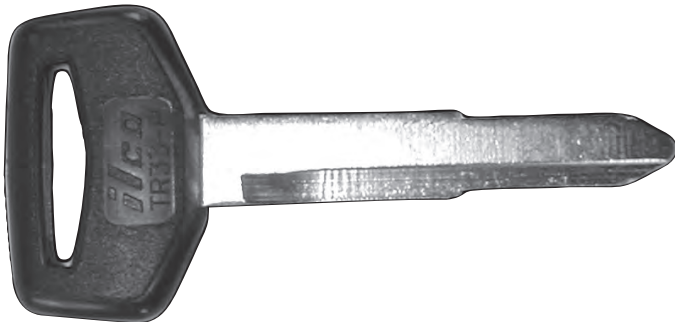

TR33P
1791181704
 Non OEM

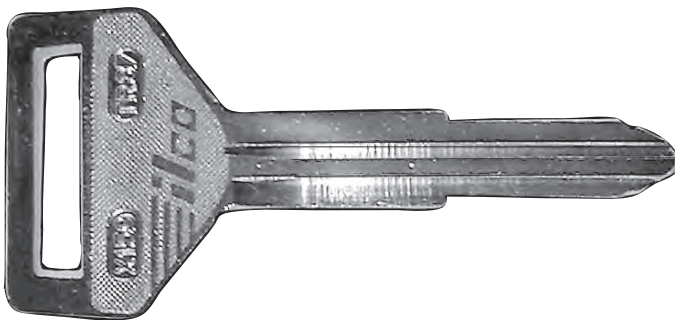

TR37
1791181599
 Non OEM

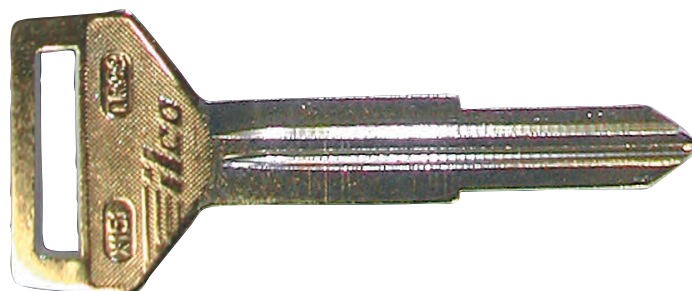

TR39
1791181537
 Non OEM

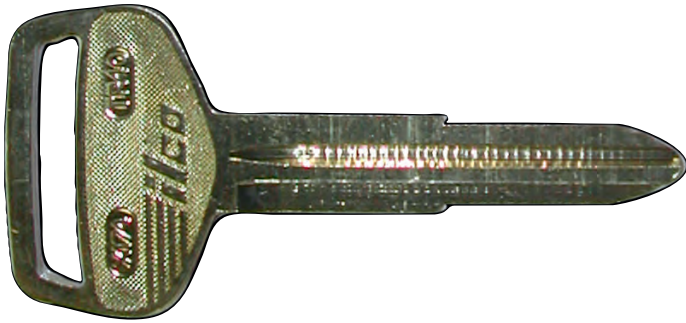
TOYOTA (CONTINUED)

TR40
1791181544
Non OEM



TR40P
1791181728
Non OEM

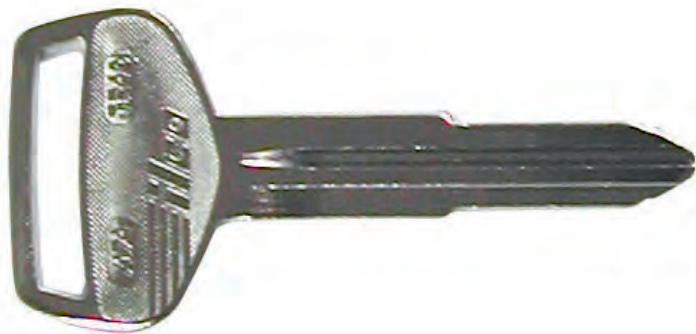

TR44
1791181544
Non OEM



TR44P
1791169610
Non OEM

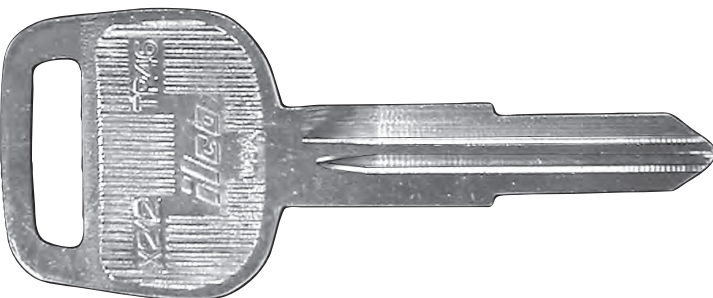

TR46
1791169641
Non OEM

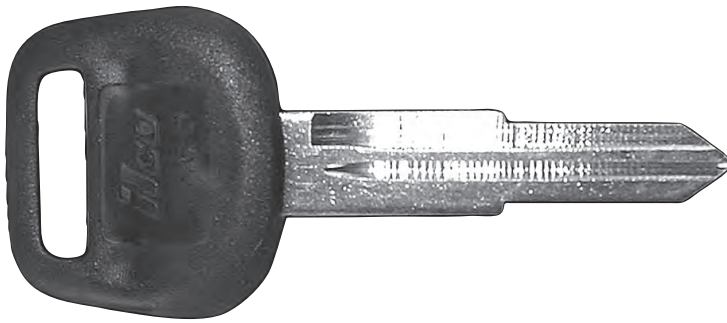

TOYOTA (CONTINUED)

TR46P
1791169627
Non OEM

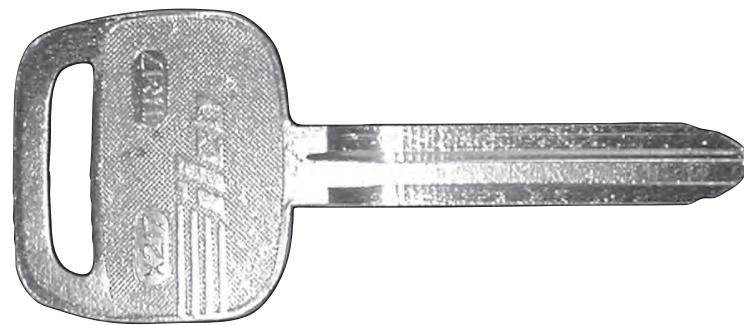

TR47
1791181551
Non OEM

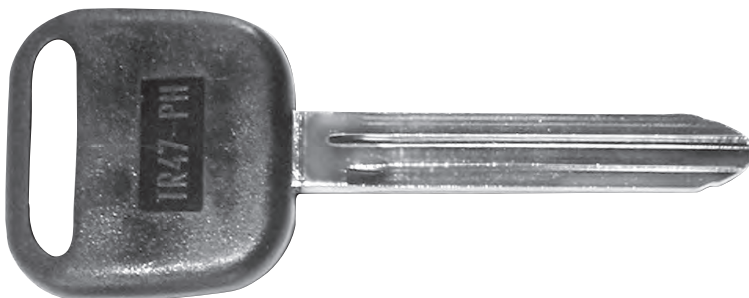

TR47P
1791181643
Non OEM

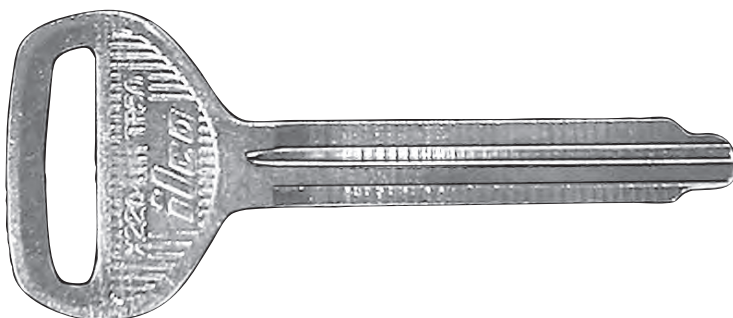

TR50
1791171101
Non OEM

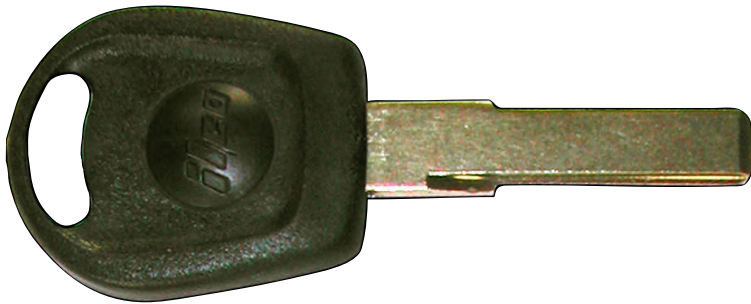
VOLKSWAGEN

HU66P
1791193899
High Security
 Non OEM

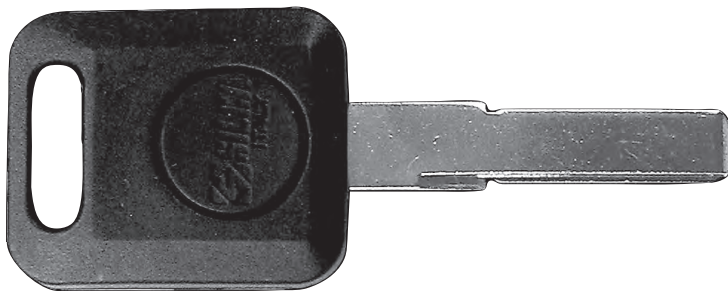

HU66T6
1791196166
Requires SDD
High Security
Transponder
 Non OEM

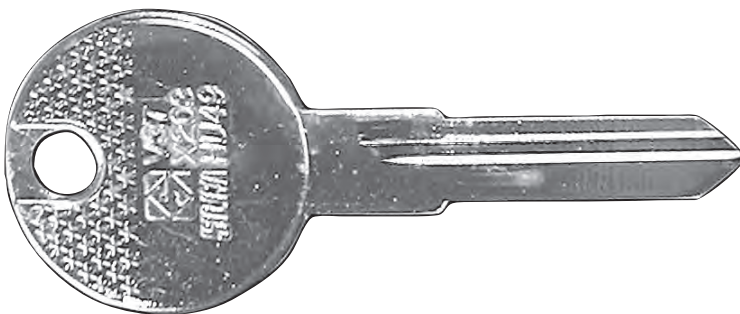

V37
1791166923
 Non OEM



V37P
1791166862
 Non OEM

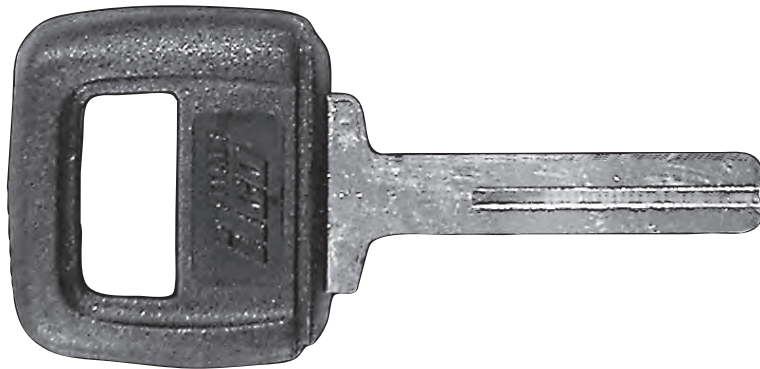

VOLVO

S66NNP
1791 165261
High Security
Non OEM

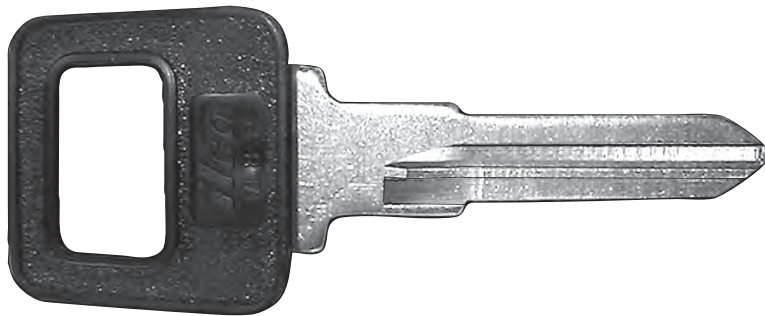

VL8
1791134069
Non OEM



MOTORCYCLES • HARLEY DAVIDSON

1137B

1791118861

Non OEM

**SDD** (Silica Diagnostic Device)**RW2** (Transponder Reader/Writer)**High Security** •**Transponder**

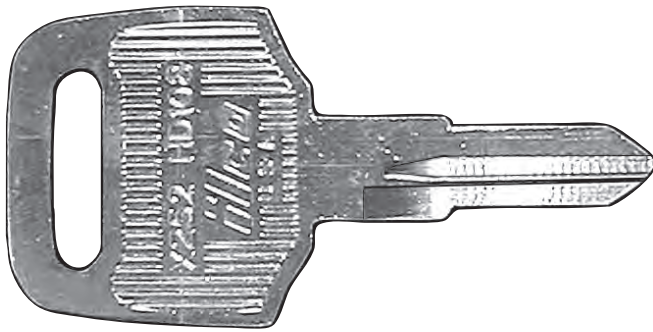
MOTORCYCLES • HONDA

HD108
1791193288
Non OEM

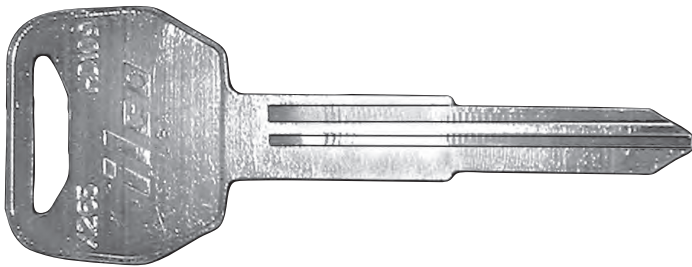

HD109
1791195077
Non OEM

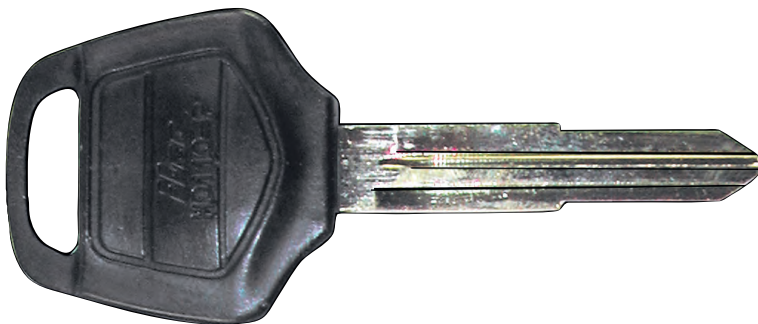

HD110P
1791198467
Non OEM



HD72
1791107889
Non OEM

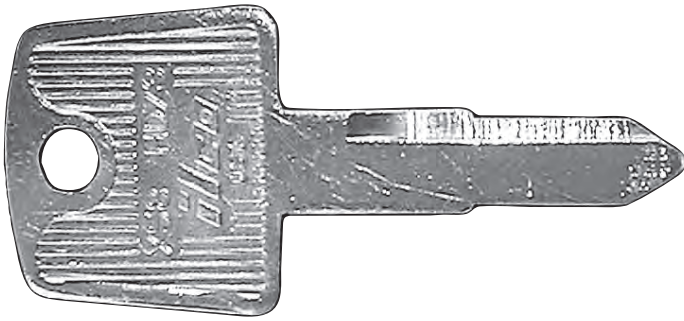

MOTORCYCLES • HONDA (CONTINUED)

HD73
1791107896
Non OEM

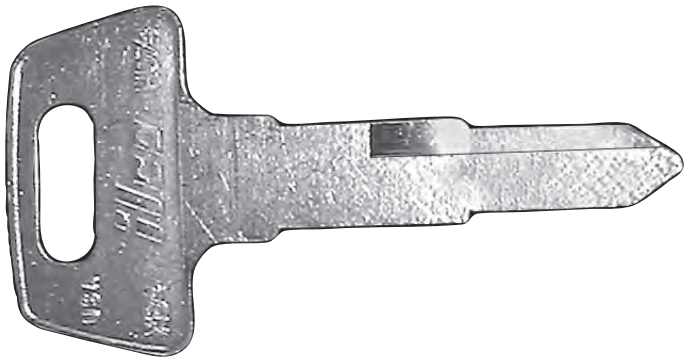

HD74
1791107872
Non OEM

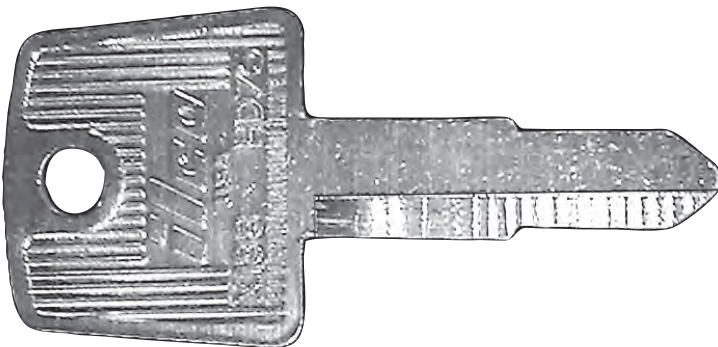

HD75
1791141203
Non OEM

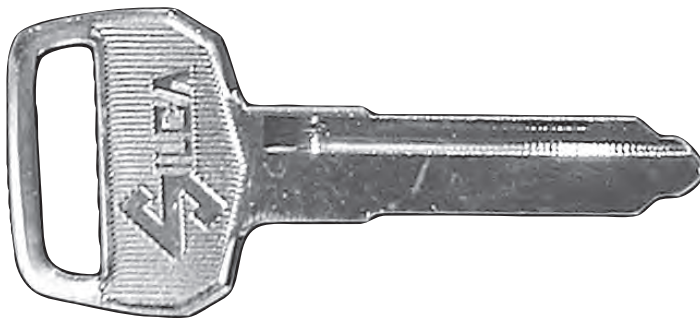

MOTORCYCLES • KAWASAKI

KA11
1791108848
Non OEM

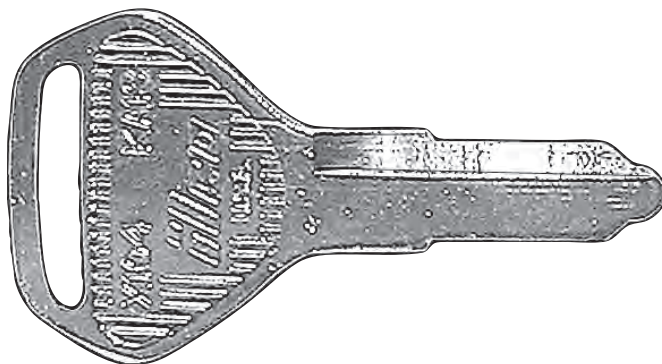

KA13
1791108701
Non OEM



KA14
1791108718
Non OEM

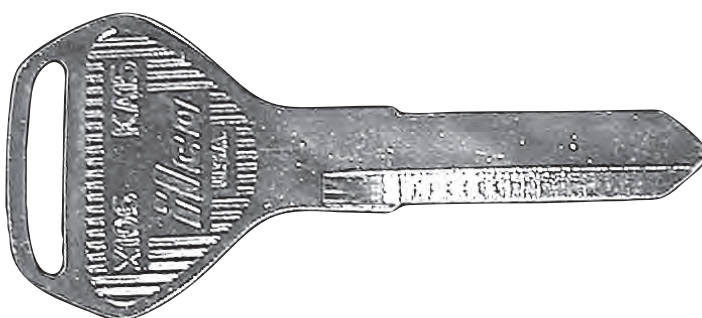

KA15
1791108855
Non OEM

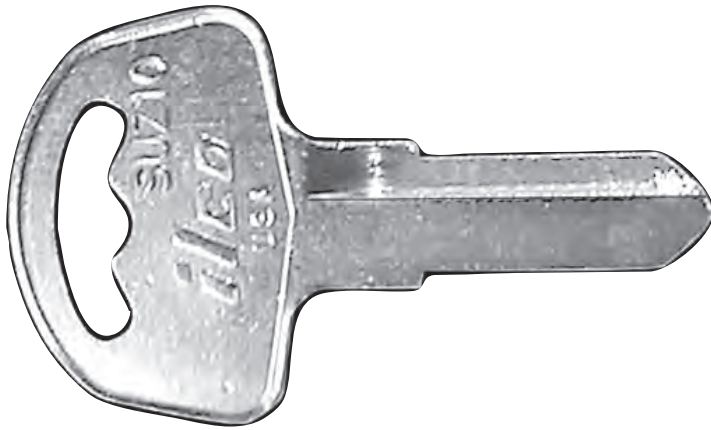
MOTORCYCLES • SUZUKI

SUZ10
1791160907
Non OEM

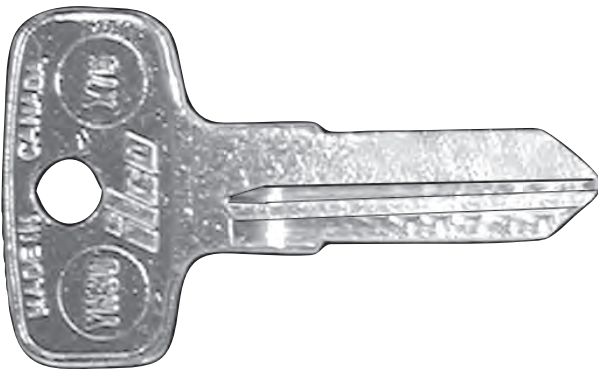

MOTORCYCLES • YAMAHA

YH30
1791107827
Non OEM

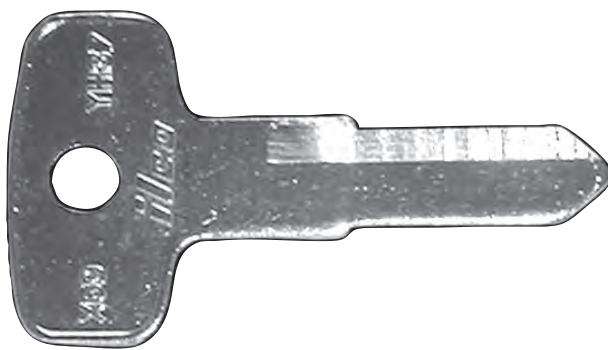

YH37
1791107735
Non OEM

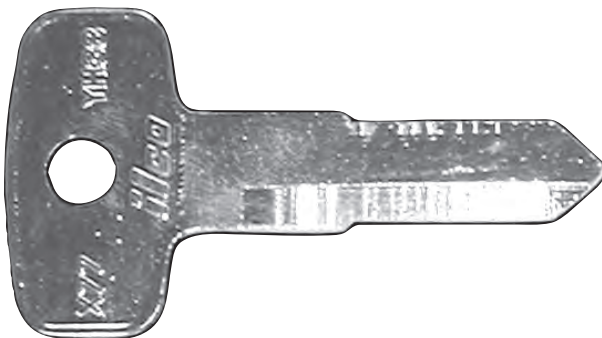

YH38
1791107742
Non OEM

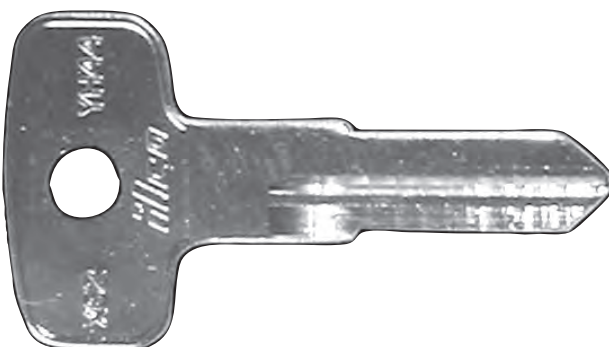

YH44
1791107711
Non OEM

MOTORCYCLES • YAMAHA (CONTINUED)

YH46
1791107926
Non OEM

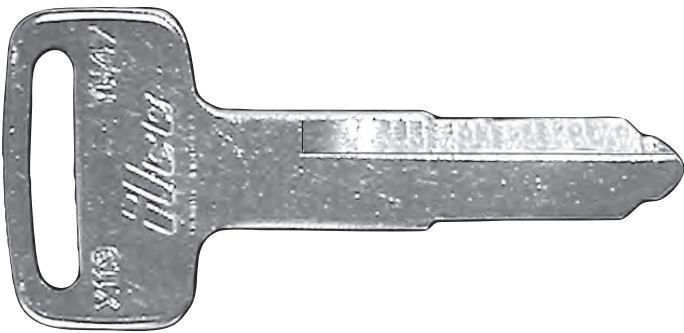

YH47
1791107933
Non OEM

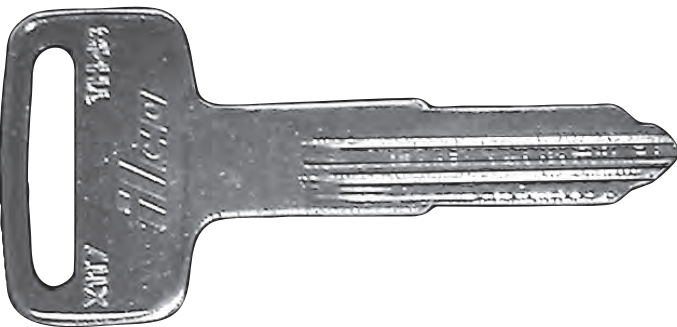

YH48
1791107940
Non OEM

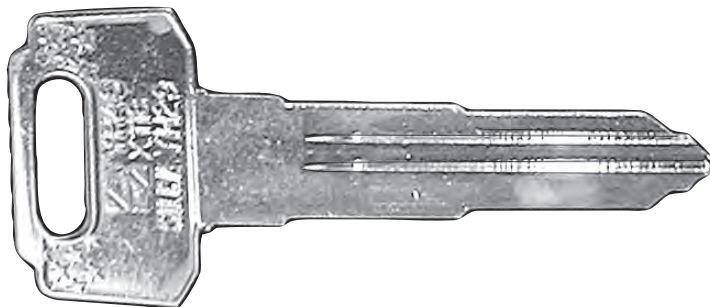

YH49
1791107957
Non OEM

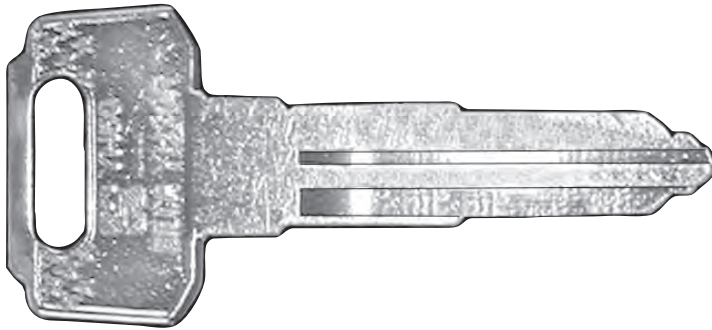
MOTORCYCLES • YAMAHA (CONTINUED)

YH50
1791107964
Non OEM

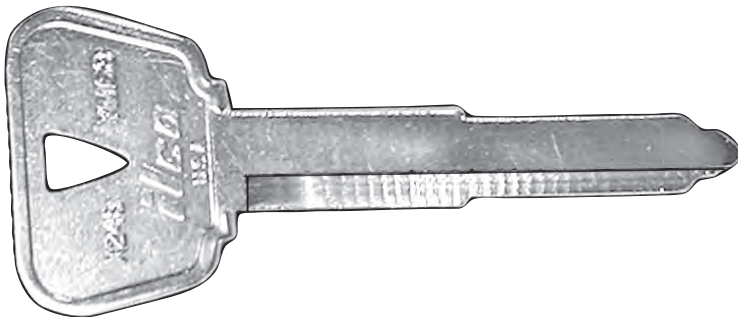

YM63
1791181445
Non OEM

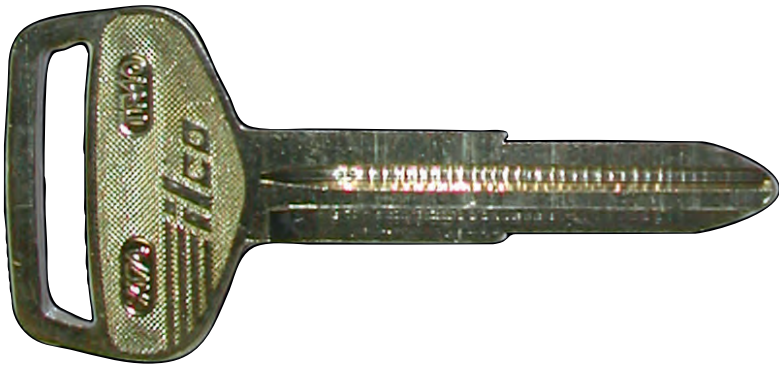

LARGE TRUCKS • DAIHATSU

TR40
1791181544
Non OEM



TR40P
1791181728
Non OEM

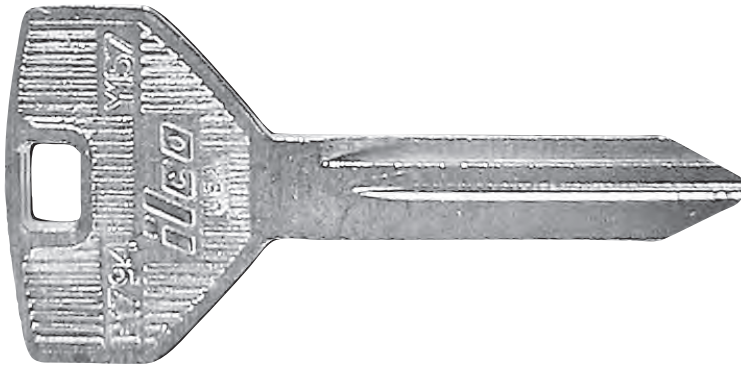

LARGE TRUCKS • FREIGHTLINER

Y157
1791175710
Non OEM



Y157P
1791175727
Non OEM

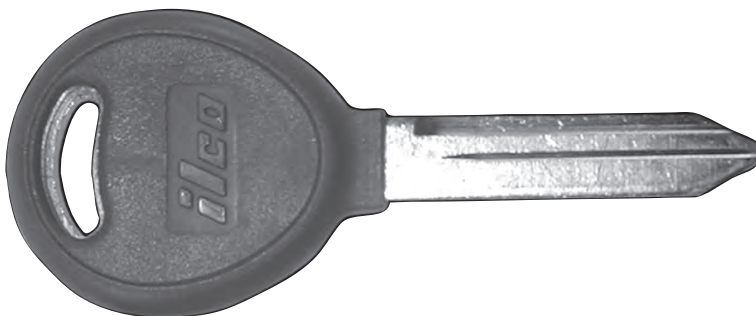

Y160PT
1791187164
Transponder
Requires SDD
or OBP
Non OEM

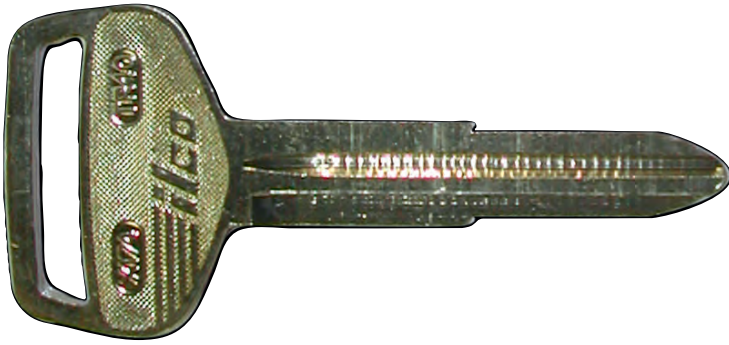

LARGE TRUCKS • HINO

TR40
1791181544
Non OEM

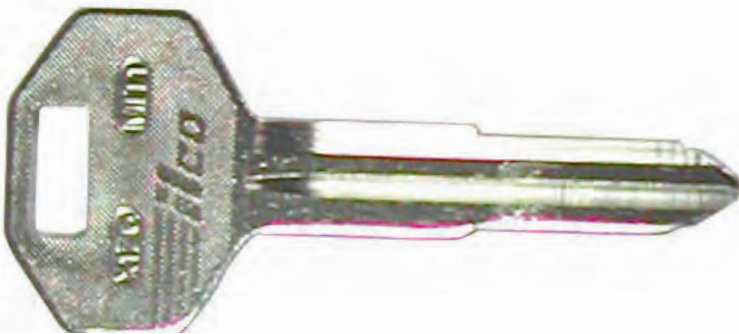

Mit1
1791181476
Non OEM



Mit1P
1791181629
Non OEM



TR40P
1791181728
Non OEM

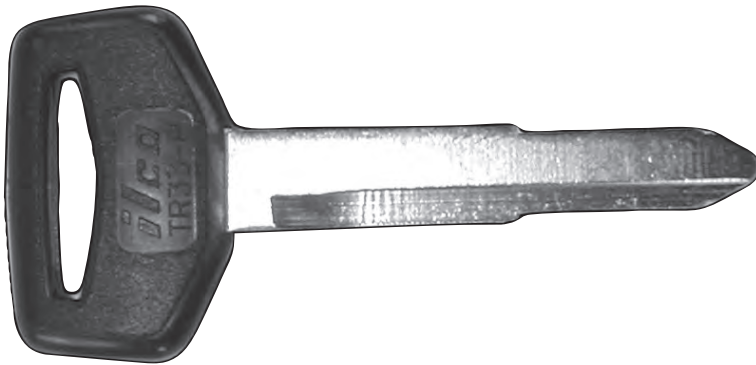

LARGE TRUCKS • HINO

TR33P
1791181704
Non OEM

LARGE TRUCKS • NAVISTAR

RA3
17913601
OEM



RA4
17913602
OEM

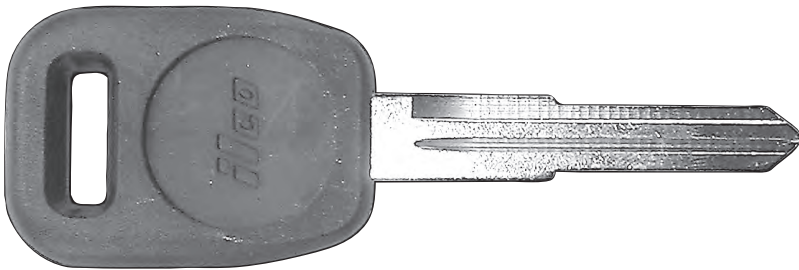

LARGE TRUCKS • PETERBUILT

RV4P
1791180073
Non OEM

LARGE TRUCKS • WHITE, GMC, VOLVO

RA4
17913602
OEM



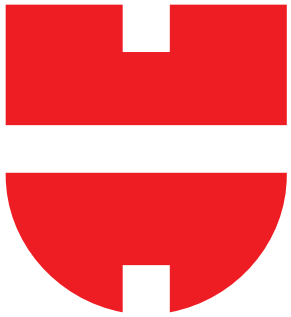

WÜRTH



WURTH USA Inc.
93 Grant Street
Ramsey, NJ 07446
1-800 WURTH USA (987-8487)
www.wurthusa.com

© WURTH USA Inc. 2011
Printed in New Jersey
The information enclosed is privileged and confidential property of WURTH
USA, Inc. Any dissemination, distribution or copying of this communication is
strictly prohibited.